

20
25



RISTORAZIONE | HOTELLERIA



LEONE dal 1945 a oggi

La nostra avventura inizia a Lugo di Romagna nel dopoguerra. Sono anni difficili dove poco o nulla è rimasto, il fondatore Luigi Tampieri insieme alla sua famiglia si rimbecca le maniche e fonda la Tampieri s.n.c. dove si producono stuzzicadenti ricavati dalla penna delle oche.

Nel 1970 Luigi lascia il posto al figlio Pietro, il nome della nostra azienda diventa Leone s.n.c. Realizziamo le prime macchine automatiche per l'imbustamento degli stuzzicadenti e cominciamo a spedire le prime cartoline per corrispondenza ai ristoranti d'Italia.

Negli anni 80 creiamo i primi decori per la gelateria e la cartolina diventa un vero e proprio catalogo.

L'azienda attraverso idee innovative e sinergie con i clienti, cresce, diventando un punto di riferimento per il proprio settore.

Sono gli anni 2000 che trasformano l'azienda in laboratorio di idee e sperimentazione spaziando nel mondo dell'ho.re.ca a 360 gradi.

Curiosità intellettuali e scelte imprenditoriali coraggiose ci hanno portato a guardare il futuro con entusiasmo e non attraverso formule economiche o percentuali. L'innovazione, la sperimentazione, la comunicazione sono il cardine su cui si muove tutto il nostro lavoro.

Mettiamo sempre in primo piano l'uomo e la sua dignità, perché coniugare gli obiettivi aziendali con le esigenze umane è il segreto della nostra impresa, ciò implica una forte responsabilità nei confronti della comunità e del pianeta.

Oggi come 80 anni fa amiamo quello che facciamo e continuiamo a farlo con passione.



Il nome della nostra azienda deriva da una piccola insegna sulla porta dove, un Leone con uno stuzzicadenti nella zampa, diceva "Adesso me li curo io", da lì, tutti cominciarono a chiamarli "gli stuzzicadenti del leone".

LEONE from 1945 till nowadays

Our business started in Lugo di Romagna during the second postwar period. These were very difficult years with very little resources and the founder, Mr. Luigi Tampieri with his family worked very hard to create Tampieri snc, that produced toothpicks from the goose feathers.

In 1970 Mr. Luigi Tampieri was replaced by his son Pietro and the company name changed to Leone snc.

We realized the first personalized packaging automatic machines and we started to send the marketing cards to all the restaurants in Italy.

In the 80's we designed the first decorations for ice cream parlours and the marketing card became the first real catalogue.

The company, thanks to the original ideas and the synergy with his customers, developed and became a benchmark for this sector.

During the 2000's the company turned to a real laboratory of ideas and tests which involved all the Ho.Re.ca product.

Our curiosity and courageous choices make us look at the future with enthusiasm; our work is principally based on innovation through research, love for environment and transparent communication.

The ethic of the company is to care for each worker and his dignity, meeting the company targets and the human resource management. A strong responsibility that reflected in the community around us and the world.

Today, as 80 years ago, we love our work and we do it with passion.

A small sign on the company door, made by a good family friend, that shown a great Lion with a toothpick in his paw said "Now I take care of them!"

From that moment in town, everybody called them "The Lion's toothpicks".



Carissimi,

con grande emozione e gratitudine celebriamo quest'anno un traguardo straordinario: gli 80 anni di attività della nostra azienda. Questo anniversario non rappresenta solo un momento di festa, ma soprattutto un'occasione per guardare al passato con orgoglio e al futuro con determinazione.

Fin dal primo giorno, Leone ha avuto un sogno: offrire qualità, innovazione e affidabilità. Questi valori ci hanno guidato attraverso i decenni, ma non sarebbe stato possibile raggiungere questa pietra miliare senza il vostro prezioso contributo.

Un ringraziamento speciale va a voi, nostri clienti, che avete creduto nei nostri prodotti e servizi, dimostrandoci fiducia e lealtà lungo il cammino. Grazie per averci scelto, sfidato a migliorarci e accompagnato nel nostro percorso di crescita.

Ai nostri partner, che con competenza e passione ci hanno supportato nelle sfide del mercato, va la nostra profonda riconoscenza. La vostra collaborazione è stata, ed è tuttora, un pilastro fondamentale per il nostro successo.

E infine, ai nostri collaboratori, il cuore pulsante di Leone: grazie per la vostra dedizione, il vostro impegno quotidiano e la vostra capacità di superare ogni ostacolo. Siete voi a dare vita ai nostri valori e a rendere possibile ciò che siamo oggi.

Guardiamo avanti con entusiasmo, certi che insieme sapremo affrontare nuove sfide e cogliere le opportunità che il futuro ci riserva. Questo traguardo è solo l'inizio di un viaggio che vogliamo continuare a percorrere con voi, fianco a fianco.

Dear All,

with great emotion and gratitude, this year we celebrate an extraordinary milestone: the 80th anniversary of our Company. This anniversary is not only a moment of celebration, but above all, an opportunity to look at the past with pride and at the future with determination.

From the very first day, Leone had the dream to offer quality, innovation, and reliability. These values guided us through the decades, but that wouldn't have been possible without the invaluable contribution of our customers.

A special thanks goes to you, dear clients, who have placed your trust in our products and services, showing us loyalty and belief along the way. Thank you for choosing us, challenging us to improve and helping us to grow.

Thank you to our partners, who have supported us through market challenges with their knowledge and passion, we express our deepest gratitude. Your collaboration has been, and continues to be, a fundamental pillar of our success.

And finally, to our employees, the beating heart of Leone: thank you for your dedication, your daily commitment and your ability to overcome every obstacle. You pursue our values and make possible what we are today.

We look forward to the future with enthusiasm and we are confident that together we will face new challenges and we will seize the opportunities that lie ahead. This milestone is just the beginning of a journey that we want to continue to walk with you, side by side.



Ottanta
anni insieme



CISQ is a member of



The International Certification Network
www.iqnet-certification.com

CERTIFICATO N. 37413/18/S CERTIFICATE No.

SI CERTIFICA CHE IL SISTEMA DI GESTIONE PER LA QUALITÀ DI
IT IS HEREBY CERTIFIED THAT THE QUALITY MANAGEMENT SYSTEM OF

LEONE - S.R.L.

Via Dogana 25 48022 LUGO (RA) ITALIA
NELLE SEGUENTI UNITÀ OPERATIVE / IN THE FOLLOWING OPERATIONAL UNITS

Via Dogana 25 48022 Lugo (RA) ITALIA

LE UNITÀ OPERATIVE INDICATE NELLE PAGINE SUCCESSIVE / AND OPERATIONAL UNITS IN THE FOLLOWING PAGES

È CONFORME ALLA NORMA / IS IN COMPLIANCE WITH THE STANDARD

ISO 9001:2015

PER I SEGUENTI CAMPI DI ATTIVITÀ / FOR THE FOLLOWING FIELD(S) OF ACTIVITIES

COMMERCIALIZZAZIONE DI ARTICOLI MONOUSO E ACCESSORI PER IL SETTORE HO.RE.CA. E PRODUZIONE DI PRODOTTI COSMETICI MONOUSO.

IAF:12
IAF:29

SALE OF SINGLE USE ITEMS AND ACCESSORIES FOR HO.RE.CA. SECTOR AND PRODUCTION OF SINGLE USE COSMETIC ARTICLES.

La validità del presente certificato è subordinata a sorveglianza periodica annuale / semestrale ed al riesame completo del sistema di gestione con periodicità triennale

The validity of this certificate is dependent on an annual / six monthly audit and on a complete review, every three years, of the management system

L'uso e la validità del presente certificato sono soggetti al rispetto del documento RINA: Regolamento per la Certificazione di Sistemi di Gestione per la Qualità

The use and validity of this certificate are subject to compliance with the RINA document : Rules for the certification of Quality Management Systems

Prima emissione <i>First Issue</i>	26.11.2018	Data decisione di rinnovo <i>Renewal decision date</i>	14.11.2024
Data scadenza <i>Expiry Date</i>	25.11.2027	Data revisione <i>Revision date</i>	14.11.2024

Rocco Amendola

Bologna Management System
Certification, Head



SGQ N° 002 A

Membro degli Accordi di Mutuo Riconoscimento EA, IAF e ILAC
Signatory of EA, IAF and ILAC Mutual Recognition Agreements

RINA Services S.p.A.
Via Corsica 12 - 16128 Genova Italy

1 / 2



www.cisq.com

CISQ è la Federazione Italiana di Organismi di Certificazione dei sistemi di gestione aziendale
CISQ is the Italian Federation of management system Certification Bodies



Lugo

Oggi Leone è un'azienda leader di mercato certificata ISO 9001:2015, che può contare su un affiatato team di 60 collaboratori.

Lo stabilimento principale dispone di 10.000mq coperti che possono contenere oltre 15.000 pallets in grado di soddisfare qualunque tipo di fornitura.

Con una capillare rete commerciale e distributiva, siamo presenti oltre che in Italia in Europa e nel mondo

Today Leone is a market leader company, certified ISO 9001:2015, that relies on a trusty staff of 60 people. The main factory has a 10.000 sq.m warehouse with more than 15.000 pallets, in order to guarantee any supply. With a widespread sales network, we can sell in Italy as well as in Europe and Worldwide.



Bagnacavallo





un'esperienza italiana



Guida ai materiali

Bamboo

Ha caratteristiche eccezionali paragonabili ai migliori legni. Le sue canne crescono con velocità sorprendente (anche oltre un metro al giorno) fino alla loro altezza massima di 15-20 metri che raggiungono nel giro di un paio di mesi. Materiale incredibilmente resistente e durevole ma anche flessibile e leggero.

Legno

Gli articoli sono ricavati da piante di coltivazioni certificate e provenienti da foreste gestite in modo responsabile, seguendo rigorosi standard ambientali e sociali. Sono piante che crescono molto velocemente, infatti bastano 5 anni per ottenere una pianta pronta per essere lavorata. Il legno utilizzato si presta a svariati utilizzi in diverse tipologie di prodotto.

Foglia di palma

Raccolte durante il normale ciclo di rinnovamento, vengono trasformate mediante lavaggio e pressatura, in piatti e ciotole resistenti all'acqua e al calore che non alterano il gusto dei cibi. Adatti per cibi sia liquidi che solidi e per es-



sere utilizzate in forno, microonde o freezer. Sono biodegradabili e compostabili.

Polpa di cellulosa

Si ricava dalle fibre della canna da zucchero. Prodotti idonei al contatto alimentare, possono essere utilizzati in forno e microonde (-10°/+120°C). Materiale completamente biodegradabile, rende più green il mondo dell'Ho.Re.Ca.

PLA

(-15°/+40°C) Polimero dell'acido lattico derivato da piante come il mais, il grano o la barbabietola prodotto attraverso un processo di fermentazione. Questi polimeri possono essere utilizzati per produrre resine simili alla plastica o fibre. È prodotto da risorse naturali rinnovabili annualmente. I prodotti



sono totalmente compostabili in 8-12 settimane.

CPLA

Variante del comune PLA ricavato dal mais, in cui l'elemento base viene cristallizzato: ne deriva un risultato completamente naturale, che assicura totale compostabilità e biodegradabilità. Grazie a tale processo, la resistenza al calore aumenta, divenendo assolutamente più adatto all'utilizzo con cibi caldi.

Melamina

Questo materiale è una resina termoindurente utilizzata anche per la realizzazione di stoviglie e accessori per la tavola. Somigliante alla porcellana nell'aspetto, è leggera e resistente e ben apprezzata dai professionisti di settore per la sua praticità e per il design innovativo. Di facile pulizia e lavabile in lavastoviglie, sopporta temperature che arrivano fino a 70°C, può essere riposta in frigorifero e in freezer e non assorbe gli odori.



Materials guide

Bamboo

It has exceptional characteristics comparable to those of the best woods. Its reeds grow with surprising speed (about a meter a day) up to their maximum height of 15-20 meters that they reach within a couple of months. It is an incredibly hard and durable material but also flexible and light.

Wood

Our wooden products come from plants of certified cultivations and from forests that are responsibly managed in conformity with strict environmental, social and economic standards. The plants grow very fast and it may be enough 5 years to have a mature plant to work. The wood can be used in many kind of items.

Palm leaf

Naturally fall-off during the normal renewal cycle, they are converted in full plates and bowls through a washing and pressing process. The items are water and heat-re-

sistant and they don't affect the taste of the food, they can contain liquid and solid food, it's can be used in traditional oven or microwave, and freezer. The items are biodegradable and compostable.

Cellulose pulp

(-10°/+120°C) It is obtained from the residual fibers of the processing in particular from sugar cane. Cellulose pulp products are suitable for food contact, heat resistant, they can be used in oven and microwave. Completely biodegradable, they make the Ho.re.Ca world more sustainable.

PLA

(-15°/+40° C) it is derived from renewable resources, such as corn starch, wheat or sugarcane. It is a bioplastic made from lactic acid and is used in the food industry to package sensitive food products. The products are totally compostable. Under optimal composting conditions, PLA products decompose in 8-12 weeks.

CPLA

Variant of the common PLA obtained from corn, where the basic element is crystallized: it derives a completely natural result, that ensures total compostability and biodegradability. Thanks to this process, the resistance to heat increases, becoming absolutely more suitable for use with hot foods.

Melamine

This material is a thermosetting resin and it is also used for creating kitchen utensils and tableware. It is very similar to porcelain; it is resistant and liked among professionals for its functionality and innovative design. Easy to clean and dishwasher safe, it can bear temperatures up to 70°C, it can be placed in the fridge or freezer and does not absorb odours.



Scheda tecnica dei materiali utilizzati

Technical specification of materials

Materiale Material	Tolleranza termica Thermal tolerance			Temp. Max*	Microonde Microwave	Forno Oven	Gr Resistente ad oli e grassi Oil and greas resistant	B Biodegradabile Biodegradable	Rc Riciclabile Recyclable
	-10° C	+70° C	+70° C						
PE Polietilene Polyethylene	-10° C	+70° C	+70° C		✗	✗	✓	✗	✓
PP Polipropilene Polypropylene	-10° C	+70° C	+70° C		✗	✗	✓	✗	✓
PS Polistirene cristallo Clear Polystyrene	-10° C	+85° C	+70° C		✗	✗	✓	✗	✓
PC Policarbonato Polycarbonate	-10° C	+100° C	+70° C		✗	✗	✓	✗	✓
PVC Polivinilcloruro Polyvinyl chloride	-10° C	+70° C	+70° C		✗	✗	✓	✗	✓
MF Melamina Melamine	-10° C	+70° C	+70° C		✗	✗	✓	✗	✗
TR Tritan Tritan	-10° C	+70° C	+70° C		✗	✗	✓	✗	✓
MA Metacrilato Methacrylate	-10° C	+85° C	+70° C		✗	✗	✓	✗	✓
PLA Acido polilattico Polylactic acid PLA	-20° C	+40° C	+40° C		✗	✗	✓	✓	✓
CPLA Acido polilattico cristallizzato Crystal Polylactic acid CPLA	-40° C	+90° C	+85° C		✓	✗	✓	✓	✓
Fe Metallo Metal	0° C	+200° C	+70° C		✗	✗	✓	✗	✓
W Legno Wood	-20° C	+100° C	+70° C		✗	✗	✓	✓	✓
AC Acrilico Acrylic	-5° C	+70° C	+70° C		✗	✗	✓	✗	✓
Wp Foglia di Palma palm leaf	-10° C	+120° C	+70° C		✓	✓	✓	✓	✓
SL Ardesia Slate	-5° C	+70° C	+70° C		✗	✗	✓	✗	✗
CT Cotone Cotton	-40° C	+180° C	+70° C		✗	✗	✓	✗	✗
Pa Carta Paper	-10° C	+70° C	+70° C		✗	✗	✓	✓	✓
TNT Tessuto non tessuto Norwoven	0° C	+50° C	+50° C		✗	✗	✗	✗	✗
PET Rpet Polietilene tereftalato Polyethylene Terephthalate	-0° C	+70° C	+70° C		✗	✗	✓	✗	✓
SS Acciaio inox Stainless steel	0° C	+200° C	+70° C		✗	✗	✓	✗	✓
CEL Polpa di cellulosa Cellulose pulp	-20° C	+120° C	+70° C		✓	✓	✓	✓	✓
PO Porcellana Porcelain	-20° C	+180° C	+70° C		✓	✓	✓	✗	✗
GI Vetro Glass borosilicate	-30° C	+300° C	+70° C		✓	✓	✓	✗	✓

* Temperatura max prodotto. Regolamento 1935/2004 (Contatto alimentare) / Max temp. Regulation 1935/2004 (Food contact)

I dati riportati sono a puro scopo indicativo, si raccomanda di verificare l'idoneità tecnologica nell'applicazione reale in base ai tempi e alle temperature d'impiego.

INFORMAZIONI SU ARTICOLI DESTINATI AL CONTATTO CON PRODOTTI ALIMENTARI

- I prodotti presenti sul Catalogo LEONE che, per loro natura, siano destinati a venire a contatto con alimenti sono conformi al regolamento UE 1935/2004 del 27/10/2004, reg. 2023/2006 del 22/12/2006;
- La ditta Leone adotta inoltre una procedura comprensiva di tutti gli aspetti previsti ai fini della rintracciabilità che:
 - consente l'eventuale esclusione dei prodotti non idonei all'immissione sul mercato;
 - dispone di un elenco aggiornato e dettagliato dei fornitori e dei clienti;
 - prevede una serie di registrazioni in grado di risalire al destinatario di ciascun prodotto immesso sul mercato.

INFORMATION ON ARTICLES INTENDED TO COME INTO CONTACT WITH FOODSTUFFS

- Products on LEONE's catalog, which by their nature, are intended to come into contact with food shall comply with the UE regulation 1935/2004 of 27/10/2004, reg-2023/2006 of 22/12/2006;
- LEONE also adopts a procedure which encompasses all aspects planned for the immediate recognition that :
 - Allows the possible exclusion of products not suitable for marketing.
 - Has a detailed and updated list of suppliers and customers.
 - Provides a series of records that can trace the recipient of each product on the market.

INFORMAZIONI SUI PRODOTTI COSMETICI

Salviette umidificate, Saponi, Bagnodoccia, Shampoo, Dentifrici, Crema da barba, Body lotion.

- Reparto di Produzione e Confezionamento: struttura a norma di legge e conforme ai parametri igienico sanitari così come previsti dal DM 328/87.
- Impianti di produzione: automatizzati e certificati per l'uso cosmetico.
- Adeguamento al Regolamento cosmetico 1223/09 con attuazione delle disposizioni GMP (Uni 22716) e predisposizione dei PIF (Product Information File) (completo di CPSR, Cosmetic Product Safety Report, CPSA, Cosmetic Product Safety Assessment).

INFORMATION ON COSMETIC PRODUCTS

Refreshing towelette, Soap, Bath foam, Toothpaste, Shaving cream, Body lotion.

- Production factory and packaging: structure complying with the law and with health and hygiene standards as provided by DM 328/87.
- Production Plants: automated and certified for cosmetic use.
- Adaptation to EC Regulation cosmetic 1223/09 with implementation of the GMP (Uni 22716) and preparation of the PIF (Product Information File) (complete CPSR, Cosmetic Product Safety Report, CPSA, Cosmetic Product Safety Assessment)

modalità d'uso / use

avvertenza/notice



Lavaggio in lavastoviglie
Dishwasher safe



Non usare lame
Not scratch-proof



Lavare a mano
Handwash



Ad esaurimento scorte
Until sold out



Misure Gastronorm
Gastronorm size



Adatto per forno
Oven-proof



Non usare su fornelli
Not flame



Personalizzabile
Customizable
pag. 264



Non usare in forno
Not in oven



Utilizzabile su fornelli
Flame ok



Adatto per congelatore
Freezer-proof



Novità Leone
Leone news



Adatto per microonde
Microwavable



Non adatto per microonde
Not microwavable



Infrangibile
Unbreakable



Prezzo ribassato
Special price



12-81

melamina
melamine



82-89

porcellana
porcelain



90-91

ulivo, ciotole e taglieri
olive wood



92-115

acacia buffet e taglieri
acacia buffet, cutboards



116-141

bamboo buffet e taglieri
bamboo buffet, cutboards



142-151

cestini
baskets



152-155

acciaio buffet
stainless steel buffet



156-159

bancaline e cassette
mini pallets, boxes



160-171

acciaio martellato
hammered stainless steel



172-175

secchielli e caraffe
ice buckets and jugs



176-177

calici e bicchieri
wine and water glasses



178-187

accessori barman
barman accessories



188-189

portabustine/tovaglioli
sachet/napkins holders



190-191

guanti forno e grembiuli
aprons and oven mitts



192-193

macina sale e pepe
salt and pepper mills



194-199

vetro, jar, vasetti
glass, jars and cups



200-203

tovaglette e runner
tablemats and runners



204-206

menu e comande
menu holders



207-211

lavagne e pennarelli
blackboards and pens



212-213

candele e accessori
candles and accessories



214-215

pasticcERIA accessori
pastry accessories



216-219

finger food naturale
natural finger food



220-221

cannucce bio
bio straws



222-229

spiedini e stuzzicadenti
sticks and toothpicks



230-234

monouso in legno
disposable wood



235-237

foglia di palma
palm leaf



238-251

polpa di cellulosa
cellulose pulp



252-269

takeaway, street food
takeaway and street food



270-271

carta antigrasso
greaseproof paper



272-273

posate compostabili
compostable cutlery



274-277

bicchieri monouso
disposable cups



278-281

sottobicchieri e pizzi
coasters and paper doilies



282-283

portaposate/tovagliette
cutlery holders/placemats



284-287

salviette umidificate
wet wipes



288

guantini monouso
food gloves



289

bavagli e cappelli cuoco
bibs and chef hats



290-305

linea cortesia hotel
amenities for hotel



306-307

espositori in plexiglass
plexiglass display stands



308-309

outlet
outlet



310-319

elenco prodotti
items list

AMAZZONIA





€ 2,84

T8711 | ciotolina | small bowl
cm Ø9,4x4 | pz. conf. 1 | c/c 36



€ 5,56

T8706 | ciotola | bowl
cm Ø14,5x14,2x7 | pz. conf. 1 | c/c 24



€ 9,20

T8704 | piatto | plate
cm Ø23,5x2,5 | pz. conf. 1 | c/c 12



€ 11,84

T8705 | piatto | plate
cm Ø27x2,5 | pz. conf. 1 | c/c 12



€ 5,72

T8709 | piatto fondo | soup plate
cm Ø18,5x4 | pz. conf. 1 | c/c 12



€ 11,32

T8710 | piatto fondo | soup plate
cm Ø24x5 | pz. conf. 1 | c/c 12



€ 8,00

T8703 | ciotola triangolare | triangle bowl
cm 18,5x6 | pz. conf. 1 | c/c 12



€ 12,80

T8702 | ciotola triangolare | triangle bowl
cm 23,5x6 | pz. conf. 1 | c/c 12



€ 4,80

T8701 | piatto triangolare | triangle plate
cm 19,2x2,5 | pz. conf. 1 | c/c 24



€ 11,44

T8700 | piatto triangolare | triangle plate
cm 26,5x2,5 | pz. conf. 1 | c/c 12



€ 7,20

T8707 | piatto rettangolare | rectangular plate | cm
23,5x15x2,5 | pz. conf. 1 | c/c 18



€ 13,84

T8708 | piatto rettangolare | rectangular plate | cm
35,5x19x2,5 | pz. conf. 1 | c/c 8



OCEANO





€ 2,84

T8691 | ciotolina | small bowl
cm Ø9,4x4 | pz. conf. 1 | c/c 36



€ 5,56

T8686 | ciotola | bowl
cm Ø14,5x14,2x7 | pz. conf. 1 | c/c 24



€ 9,20

T8684 | piatto | plate
cm Ø23,5x2,5 | pz. conf. 1 | c/c 12



€ 11,84

T8685 | piatto | plate
cm Ø27x2,5 | pz. conf. 1 | c/c 12



€ 5,72

T8689 | piatto fondo | soup plate
cm Ø18,5x4 | pz. conf. 1 | c/c 12



€ 11,32

T8690 | piatto fondo | soup plate
cm Ø24x5 | pz. conf. 1 | c/c 12



€ 8,00

T8683 | ciotola triangolare | triangle bowl
cm 18,5x6 | pz. conf. 1 | c/c 12



€ 12,80

T8682 | ciotola triangolare | triangle bowl
cm 23,5x6 | pz. conf. 1 | c/c 12



€ 4,80

T8681 | piatto triangolare | triangle plate
cm 19,2x2,5 | pz. conf. 1 | c/c 24



€ 11,44

T8680 | piatto triangolare | triangle plate
cm 26,5x2,5 | pz. conf. 1 | c/c 12



€ 7,20

T8687 | piatto rettangolare | rectangular plate | cm
23,5x15x2,5 | pz. conf. 1 | c/c 18



€ 13,84

T8688 | piatto rettangolare | rectangular plate | cm
35,5x19x2,5 | pz. conf. 1 | c/c 8



GALASSIA





€ 2,84

T8671 | ciotolina | small bowl
cm Ø9,4x4 | pz. conf. 1 | c/c 36



€ 5,56

T8666 | ciotola | bowl
cm Ø14,5x14,2x7 | pz. conf. 1 | c/c 24



€ 9,20

T8664 | piatto | plate
cm Ø23,5x2,5 | pz. conf. 1 | c/c 12



€ 11,84

T8665 | piatto | plate
cm Ø27x2,5 | pz. conf. 1 | c/c 12



€ 5,72

T8669 | piatto fondo | soup plate
cm Ø18,5x4 | pz. conf. 1 | c/c 12



€ 11,32

T8670 | piatto fondo | soup plate
cm Ø24x5 | pz. conf. 1 | c/c 12



€ 8,00

T8663 | ciotola triangolare | triangle bowl
cm 18,5x6 | pz. conf. 1 | c/c 12



€ 12,80

T8662 | ciotola triangolare | triangle bowl
cm 23,5x6 | pz. conf. 1 | c/c 12



€ 4,80

T8661 | piatto triangolare | triangle plate
cm 19,2x2,5 | pz. conf. 1 | c/c 24



€ 11,44

T8660 | piatto triangolare | triangle plate
cm 26,5x2,5 | pz. conf. 1 | c/c 12



€ 7,20

T8667 | piatto rettangolare | rectangular plate |
cm 23,5x15x2,5 | pz. conf. 1 | c/c 18



€ 13,84

T8668 | piatto rettangolare | rectangular plate |
cm 35,5x19x2,5 | pz. conf. 1 | c/c 8





€ 17,38

T8526.Q | ciotola verde | green bowl
cm Ø19,6x9,5 | pz. conf. 1 | c/c 12



€ 15,68

T8527.Q | ciotola verde | green bowl
cm Ø17,9x8,5 | pz. conf. 1 | c/c 12



€ 17,38

T8526.Z | ciotola nera | black bowl
cm Ø19,6x9,5 | pz. conf. 1 | c/c 12



€ 15,68

T8527.Z | ciotola nera | black bowl
cm Ø17,9x8,5 | pz. conf. 1 | c/c 12



€ 17,38

T8526.Y | ciotola bianca | white bowl
cm Ø19,6x9,5 | pz. conf. 1 | c/c 12



€ 15,68

T8527.Y | ciotola bianca | white bowl
cm Ø17,9x8,5 | pz. conf. 1 | c/c 12



POKÈ



€ 4,95

T8646 | piatto | plate
cm 17x17x2 | pz. conf. 1 | c/c 24



€ 6,60

T8643 | ciotola decorata | decorated bowl
cm Ø20,5x5,5 | pz. conf. 1 | c/c 24



€ 3,96

T8645 | piatto | plate |
cm Ø18x1,8 | pz. conf. 1 | c/c 36



€ 5,01

T8640 | piatto decorato | decorated plate
cm Ø21,5x2 | pz. conf. 1 | c/c 36



€ 6,60

T8641 | piatto decorato | decorated plate
cm Ø26,5x2 | pz. conf. 1 | c/c 24



€ 15,68

T8644 | ciotola decorata | decorated bowl
cm Ø30x9 | pz. conf. 1 | c/c 12



€ 13,15

T8642 | piatto decorato | decorated plate
cm Ø35,5x3 | pz. conf. 1 | c/c 12



CORFÙ

ZANTE



€ 6,60

T8633 | ciotola decorata | decorated bowl
cm Ø20,5x5,5 | pz. conf. 1 | c/c 24



€ 4,95

T8636 | piatto | plate
cm 17x17x2 | pz. conf. 1 | c/c 24



€ 3,96

T8635 | piatto | plate
cm Ø18x1,8 | pz. conf. 1 | c/c 36



€ 5,01

T8630 | piatto decorato | decorated plate
cm Ø21,5x2 | pz. conf. 1 | c/c 36



€ 6,60

T8631 | piatto decorato | decorated plate
cm Ø26,5x2 | pz. conf. 1 | c/c 24



€ 15,68

T8634 | ciotola decorata | decorated bowl
cm Ø30x9 | pz. conf. 1 | c/c 12



€ 13,15

T8632 | piatto decorato | decorated plate
cm Ø35,5x3 | pz. conf. 1 | c/c 12





€ 6,60

T8653 | ciotola decorata | decorated bowl
cm Ø20,5x5,5 | pz. conf. 1 | c/c 24



€ 4,95

T8656 | piatto | plate |
cm 17x17x2 | pz. conf. 1 | c/c 24



€ 3,96

T8655 | piatto | plate
cm Ø18x1,8 | pz. conf. 1 | c/c 36



€ 5,01

T8650 | piatto decorato | decorated plate
cm Ø21,5x2 | pz. conf. 1 | c/c 36



€ 6,60

T8651 | piatto decorato | decorated plate
cm Ø26,5x2 | pz. conf. 1 | c/c 24



€ 15,68

T8654 | ciotola decorata | decorated bowl
cm Ø30x9 | pz. conf. 1 | c/c 12



€ 13,15

T8652 | piatto decorato | decorated plate
cm Ø35,5x3 | pz. conf. 1 | c/c 12



ITACA



T8230 | ciotola tonda | round bowl
cm Ø 18,4x7,5 | pz. conf. 1 | c/c 18

€ 7,52



T8234 | coppetta tonda | round bowl
cm Ø 14,7x5,5 | pz. conf. 1 | c/c 24

€ 5,19



T8231 | ciotola tonda | round bowl
cm Ø 20,3x8,5 | pz. conf. 1 | c/c 12

€ 10,63



T8236 | coppetta tonda | round bowl
cm Ø 11,7x3,6 | pz. conf. 1 | c/c 32

€ 3,90



T8232 | ciotola tonda | round bowl
cm Ø 23,3x9,7 | pz. conf. 1 | c/c 12

€ 13,46



T8237 | coppetta tonda | round bowl
cm Ø 15,3x4,3 | pz. conf. 1 | c/c 18

€ 6,73



TERRACOTTA



IBIZA



€ 11,31

T8623 | piatto decorato | decorated plate
cm 26,5x20,8x2,7 | pz. conf. 1 | c/c 12



€ 5,49

T8622 | piatto decorato | decorated plate
cm 22,4x15,5x2 | pz. conf. 1 | c/c 12



€ 8,95

T8620 | piatto decorato | decorated plate
cm 20,8x20x3,8 | pz. conf. 1 | c/c 12



€ 7,83

T8621 | piatto decorato | decorated plate
cm 25,6x15,7x3,4 | pz. conf. 1 | c/c 12



RAMEN



€ 10,29

T8515.T | ciotola grigio-bianco | grey-white bowl
cm Ø 22,8x8,3 | pz. conf. 1 | c/c 24



€ 10,29

T8515.G | ciotola giallo-bianco | yellow-white bowl
cm Ø 22,8x8,3 | pz. conf. 1 | c/c 24



€ 10,29

T8515.I | ciotola blu-bianco | blue-white bowl
cm Ø 22,8x8,3 | pz. conf. 1 | c/c 24



€ 4,65

T8516 | vaschetta rettangolare | rectangular tray
cm 22x15x3,5 | pz. conf. 1 | c/c 16



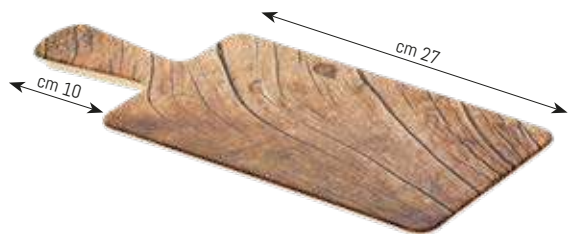

€ 11,23

T8346 | tagliere effetto legno | wood effect tray
cm 37x14x1,5 | pz. conf. 1 | c/c 12



€ 20,57

T8344 | tagliere effetto legno | wood effect tray
cm Ø32x1,5 | pz. conf. 1 | c/c 12

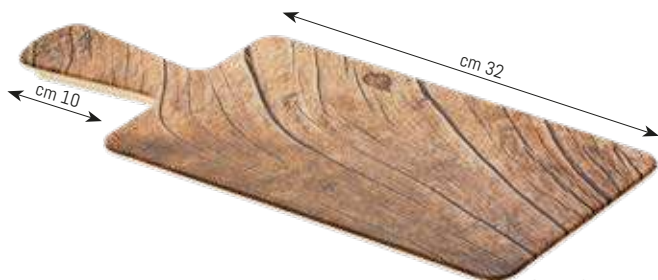

€ 15,35

T8347 | tagliere effetto legno | wood effect tray
cm 42x18x1,5 | pz. conf. 1 | c/c 12



€ 26,06

T8345 | tagliere effetto legno | wood effect tray
cm Ø36x1,5 | pz. conf. 1 | c/c 12



WOOD



€ 3,44

T8531 | ciotola | bowl
cm Ø12,7x4,5 | pz. conf. 1 | c/c 36



€ 2,59

T8506 | ciotola tonda | round bowl
cm Ø 11,5x4 | pz. conf. 1 | c/c 48



€ 3,33

T8504 | ciotola tonda | round bowl
cm Ø 14x5,5 | pz. conf. 1 | c/c 48



€ 9,93

T8505 | ciotola tonda | round bowl
cm Ø 21,6x7,6 | pz. conf. 1 | c/c 24



€ 5,85

T8508 | piatto tondo | round dish
cm Ø 21,5x5,5 | pz. conf. 1 | c/c 36





€ 1,43

T8511 | cucchiaino | spoon
cm 15,3x4,7x5 | pz. conf. 1 | c/c 96



€ 1,34

T8513 | coppetta ovale | oval bowl
cm 10,3x8,9x5 | pz. conf. 1 | c/c 48



€ 2,46

T8534 | tris ciotolina quadrata | square bowl set |
cm 17,5x6,5x2,8 | pz. conf. 1 | c/c 36



€ 1,80

T8533 | bis ciotolina quadrata | square bowl set |
cm 11,5x6,5x2,8 | pz. conf. 1 | c/c 48



€ 2,34

T8509 | piatto ovale | oval dish
cm 18x10x3,5 | pz. conf. 1 | c/c 48



€ 3,63

T8510 | piatto ovale | oval dish
cm 25x13,6x4,3 | pz. conf. 1 | c/c 24



€ 4,23

T8502 | piatto ovale | oval dish
cm 25x15x1,8 | pz. conf. 1 | c/c 36



€ 9,97

T8503 | piatto ovale | oval dish
cm 35x24,8x1,6 | pz. conf. 1 | c/c 18



€ 4,95

T8500 | vassoio quadrato | square tray
cm 17x17x1,8 | pz. conf. 1 | c/c 24



€ 7,57

T8501 | vassoio rettangolare | rectangular tray |
cm 27,4x14,3x2,2 | pz. conf. 1 | c/c 24





€ 1,15

T8181 | coppetta bianca | white small cup
cm Ø9x2,4 | pz. conf. 1 | c/c 84



€ 1,78

T8183 | ciotolina bianca | white cup
cm Ø9,3x5 | pz. conf. 1 | c/c 48



€ 1,56

T8100 | coppetta bianca | white small cup
cm 10x9x5 | pz. conf. 1 | c/c 48



€ 1,87

T8182 | coppetta bianca | white cup
cm 9,4x7,5x4 | pz. conf. 1 | c/c 48



€ 1,25

T8175 | ciotolina Candy | small bowl Candy
cm Ø 7x3,7 | pz. conf. 1 | c/c 120



€ 1,78

T8111 | coppetta quadrata | square small cup |
cm 8,5x8,5x4,5 | pz. conf. 1 | c/c 48



€ 1,61

T8171 | coppetta bianca | white small cup
cm 13x11,5x4,5 | pz. conf. 1 | c/c 72



€ 3,45

T8112 | coppetta 2 scomparti | double cup
cm 16x8,5x5 | pz. conf. 1 | c/c 48



€ 3,55

T8007 | vaschetta acquamarina | acquamarina bowl |
cm 22x7x2,5 | pz. conf. 1 | c/c 48



€ 5,13

T8113 | coppetta 3 scomparti | triple cup
cm 24,5x8,5x5 | pz. conf. 1 | c/c 36







APERITIVI









€ 1,11

T8110 | piattino rettangolare | rectangular small dish |  
cm 9,5x6x3 | pz. conf. 1 | c/c 48  







€ 1,84

T8179 | ciotola quadrata | square bowl |  
cm 9,7x9,7x3,5 | pz. conf. 1 | c/c 30  







€ 3,34

T8156 | ciotola quadrata | square bowl |  
cm 11,5x14x4 | pz. conf. 1 | c/c 48  







€ 2,23

T8109 | coppetta bianca | white small cup |  
cm Ø 11x5,6 | pz. conf. 1 | c/c 48  







€ 5,75

T8446 | vassoio rettangolare | rectangular tray |  
cm 28x9x4 | pz. conf. 1 | c/c 24  







€ 2,46

T8184 | ciotola bianca | white bowl |  
cm Ø11,5x5,7 | pz. conf. 1 | c/c 48  







€ 1,78

T8176 | piattino Wipe | small plate Wipe |  
cm 16x6,3x2,7 | pz. conf. 1 | c/c 100  







€ 4,59

T8155 | ciotola doppia | double cup |  
cm 24x8x4,3 | pz. conf. 1 | c/c 36  







€ 5,34

T8104 | coppa a goccia | drop cup |  
cm Ø 20x15x7,5 | pz. conf. 1 | c/c 24  



€ 1,89

T8101 | coppetta bianca | white small cup |  
cm 15x12,5x5 | pz. conf. 1 | c/c 48  

A collection of appetizers in white bowls and a tray on a grey surface. The dishes include: a large bowl of pasta with green herbs; a bowl of fried potatoes with a rosemary sprig; a bowl of fried balls with green herbs; a bowl of roasted red peppers with thyme; a tray of yellow soup with red peppers and dill; and a tray of green dip with cilantro and red onions. A glass of yellow beverage is visible in the background.

APPETIZER

POGGIA POSATE



€ 7,56

T8195.Z | poggia posate nero | black cutlery holder | cm 8x2x1 | pz. conf. 6 | c/c 20



€ 12,15

T8198 | poggia posate bianco | white cutlery holder | cm 10x10x2 | pz. conf. 6 | c/c 8



€ 7,56

T8195.T | poggia posate grigio | grey cutlery holder | cm 8x2x1 | pz. conf. 6 | c/c 20



€ 7,56

T8195 | poggia posate bianco | white cutlery holder | cm 8x2x1 | pz. conf. 6 | c/c 20



FINGER FOOD





€ 2,61

T8185

bicchierino | small cup cm Ø6,5x7 |
pz. conf. 1 | c/c 60

T8185.Z



€ 2,61

T8186

bicchierino | small cup
cm 6x6x8 | pz. conf. 1 | c/c 60

T8186.Z



€ 2,61

T8187

coppetta quadrata | square cup
cm 6,5x6,5x5,5 | pz. conf. 1 | c/c 60

T8187.Z



€ 2,61

T8188

coppetta quadrata | square cup
cm 8x8x6,3 | pz. conf. 1 | c/c 60

T8188.Z



€ 2,61

T8189

bicchierino | small cup
cm Ø7x6,3 | pz. conf. 1 | c/c 60

T8189.Z



€ 2,61

T8194

bicchierino | small cup
cm 7,9x7,3x7 | pz. conf. 1 | c/c 60

T8194.Z



€ 1,51

T8190

foglia | leaf |
cm 10,5x4,5x2,2 | pz. conf. 1 | c/c 60

T8190.Z



€ 1,51

T8193

Piattino triangolare | small triangular dish
cm 6,9x1,5 | pz. conf. 1 | c/c 60

T8193.Z



€ 1,51

T8191

piattino quadrato | small square dish
cm 8x8x1,3 | pz. conf. 1 | c/c 60

T8191.Z



€ 2,61

T8192

piattino quadrato | small square dish
cm 12x12x1,3 | pz. conf. 1 | c/c 60

T8192.Z





€ 1,51

T8165

T8165.Z

ciotolina goccia | drop-shaped bowl
cm Ø 10x6,5x2,4 | pz. conf. 1 | c/c 96



€ 1,51

T8164

T8164.Z

ciotolina tonda | round bowl
cm Ø 7x3,5 | pz. conf. 1 | c/c 60



€ 1,51

T8163

T8163.Z

ciotolina quadrata | square bowl
cm 7,5x7,5x2,7 | pz. conf. 1 | c/c 96



€ 1,51

T8166

T8166.Z

cucchiaio | spoon
cm 14,5x4,5x1,5 | pz. conf. 1 | c/c 96





€ 4,90

T8157 | piatto rettangolare | rectangular dish
cm 23x14x2,6 | pz. conf. 1 | c/c 24



€ 4,95

T8428 | piatto quadrato | square plate |
cm 17x17x2 | pz. conf. 1 | c/c 24



€ 7,30

T8158 | piatto rettangolare | rectangular dish |
cm 28,6x18x2,8 | pz. conf. 1 | c/c 18



€ 7,02

T8134 | vassoio rettangolare | rectangular tray
cm 27x12x2,5 | pz. conf. 1 | c/c 18



€ 10,47

T8142 | vassoio rettangolare | rectangular tray |
cm 33x20x2,5 | pz. conf. 1 | c/c 18



€ 9,47

T8136 | vassoio rettangolare | rectangular tray |
cm 30x18x2,5 | pz. conf. 1 | c/c 18



€ 14,20

T8143 | vassoio rettangolare | rectangular tray |
cm 38x23x3 | pz. conf. 1 | c/c 12



€ 15,65

T8137 | vassoio rettangolare | rectangular tray |
cm 36x21x2,5 | pz. conf. 1 | c/c 12



€ 21,45

T8144 | vassoio rettangolare | rectangular tray |
cm 44x27x3 | pz. conf. 1 | c/c 6



€ 9,35

T8135 | vassoio rettangolare | rectangular tray |
cm 36x11,5x2,5 | pz. conf. 1 | c/c 12



WHITE TRAY





€ 4,03

T8130 | vassoio rettangolare | rectangular tray |
cm 24x10x2 | pz. conf. 1 | c/c 24



€ 3,11

T8120 | salsiera bianca | white sauce boat
cm 21x7x4,5 | pz. conf. 1 | c/c 48



€ 6,13

T8131 | vassoio rettangolare | rectangular tray |
cm 33x12x2 | pz. conf. 1 | c/c 18



€ 3,23

T8121 | piatto ovale | oval plate
cm 28x10x4 | pz. conf. 1 | c/c 36



€ 8,68

T8132 | vassoio rettangolare | rectangular tray |
cm 32x12x2 | pz. conf. 1 | c/c 12



€ 5,18

T8159 | vassoio rettangolare | rectangular tray |
cm 31x8,2x3,3 | pz. conf. 1 | c/c 24



€ 9,92

T8133 | vassoio rettangolare | rectangular tray |
cm 37x11x2,5 | pz. conf. 1 | c/c 12



€ 8,68

T8124 | piatto salsiera | sauce boat plate
cm 30x15x5,5 | pz. conf. 1 | c/c 18







€ 6,47

T8180 | piatto pesce | fish-shaped plate
cm 38x22x3 | pz. conf. 1 | c/c 18



€ 2,03

T8169 | piatto piano | flat dish
cm Ø 20x2 | pz. conf. 1 | c/c 60



€ 6,46

T8161 | piatto con salsiera | dish sauce holder |
cm 33x17,5x3,2 | pz. conf. 1 | c/c 24



€ 2,39

T8167 | piatto piano | flat dish
cm Ø 23x2 | pz. conf. 1 | c/c 60



€ 8,17

T8447 | piatto bianco | white plate
cm Ø20,5x4,8 | pz. conf. 1 | c/c 18



€ 5,49

T8467 | piatto rotondo | round plate |
cm Ø 20x2 | pz. conf. 1 | c/c 24



€ 13,12

T8448 | piatto bianco | white plate
cm Ø24x4,5 | pz. conf. 1 | c/c 12



€ 7,11

T8468 | piatto rotondo | round plate |
cm Ø 24x2 | pz. conf. 1 | c/c 18



€ 12,03

T8126 | piatto rotondo | round dish
cm Ø 30x6 | pz. conf. 1 | c/c 12



€ 8,51

T8469 | piatto rotondo | round plate |
cm Ø 27x2 | pz. conf. 1 | c/c 12







€ 4,56

T8128 | ciotola quadrata | square bowl
cm 18x18x6 | pz. conf. 1 | c/c 36



€ 4,01

T8105 | ciotola rettangolare | rectangular bowl |
cm 17x13x6 | pz. conf. 1 | c/c 48



€ 6,85

T8129 | ciotola quadrata | square bowl
cm 21x21x7 | pz. conf. 1 | c/c 24



€ 9,47

T8106 | ciotola rettangolare | rectangular bowl |
cm 25x20x9 | pz. conf. 1 | c/c 24



€ 10,47

T8122 | piatto ovale | white oval dish
cm 33,5x20x6 | pz. conf. 1 | c/c 18



€ 29,00

T8466 | ciotola rotonda | round bowl |
cm Ø 20x14,6 | pz. conf. 1 | c/c 4



€ 2,26

T8168 | piatto fondo | soup dish
cm Ø 21x4 | pz. conf. 1 | c/c 60



€ 2,71

T8102 | piatto fondo | deep plate
cm Ø 17,5x6 | pz. conf. 1 | c/c 48



€ 4,64

T8119 | piatto ovale | oval dish
cm 32x16,5x6 | pz. conf. 1 | c/c 36



€ 3,68

T8103 | piatto fondo | deep plate
cm Ø 20x6,5 | pz. conf. 1 | c/c 48



BREAKFAST





€ 3,01

T8107 | ciotola cilindrica | cylindrical bowl
cm Ø 11x10 | pz. conf. 1 | c/c 48



€ 4,74

T8108 | ciotola cilindrica | cylindrical bowl
cm Ø 14x10 | pz. conf. 1 | c/c 36



€ 2,37

T8177 | ciotola Moon | round bowl Moon
cm Ø 15x7,4 | pz. conf. 1 | c/c 60



€ 1,61

T8138 | cucchiaino bianco | white spoon
cm 26,5 | pz. conf. 1 | c/c 48



€ 4,34

T8173 | tazza bianca | white cup
cm Ø 8,5x10 | pz. conf. 1 | c/c 24



€ 4,46

T8197 | scolapasta bianco | white colander |
cm Ø 15,4x7,5 | pz. conf. 1 | c/c 24



€ 1,67

T8036 | bicchiere melamina | melamine cup
cm Ø 7,5x11 | 300ml | pz. conf. 1 | c/c 24



€ 4,46

T8197.Z | scolapasta nero | black colander |
cm Ø 15,4x7,5 | pz. conf. 1 | c/c 24



€ 4,46

T8197.T | scolapasta grigio | grey colander |
cm Ø 15,4x7,5 | pz. conf. 1 | c/c 24









€ 15,11

T8178 | ciotola Moon | round bowl Moon
cm Ø 30x74 | pz. conf. 1 | c/c 12



€ 79,84

T8151 | vassoio conchiglia | shell tray
cm 55x28x17 | pz. conf. 1 | c/c 2



€ 17,15

T8147 | insalatiera bianca | white salad bowl
cm Ø 40x6 | pz. conf. 1 | c/c 12



€ 18,27

T8140 | vassoio quadrato | square tray
cm 30x30x4 | pz. conf. 1 | c/c 8



€ 13,93

T8148 | insalatiera bianca | white salad bowl
cm Ø 36x11 | pz. conf. 1 | c/c 12



€ 8,33

T8196 | Piatto a 5 scomparti | 5 compartments
plate cm 23x21x1,5 | pz. conf. 1 | c/c 24



€ 15,82

T8150 | piatto piano | flat plate
cm Ø 40x3,5 | pz. conf. 1 | c/c 12



€ 19,21

T8141 | piatto design | design dish
cm 29x29x5,5 | pz. conf. 1 | c/c 12





€ 18,66

T8149 | vassoio ovale | oval tray
cm 60x23x4 | pz. conf. 1 | c/c 6



€ 14,59

T8145 | vassoio ovale | oval tray
cm 45x21x5 | pz. conf. 1 | c/c 12



€ 33,31

T8170 | vassoio ovale | oval tray
cm 69x29x6,3 | pz. conf. 1 | c/c 6



€ 17,49

T8146 | vassoio ovale | oval tray
cm 49,5x23x5 | pz. conf. 1 | c/c 12



€ 22,58

T8436 | vassoio ovale | oval tray
cm 60x30x1,6 | pz. conf. 1 | c/c 6



€ 14,18

T8435 | vassoio ovale | oval tray
cm 45x25x1,6 | pz. conf. 1 | c/c 8



€ 27,50

T8439 | vassoio ovale | oval tray
cm 60x30x6,5 | pz. conf. 1 | c/c 4



€ 26,04

T8438 | vassoio ovale | oval tray
cm 45x25x6,5 | pz. conf. 1 | c/c 4







€ 9,31

T8020.Z | vassoio nero | black tray | cm 35x24x2,3 |
pz. conf. 1 | c/c 12



€ 9,31

T8020 | vassoio bianco | white tray | cm 35x24x2,3 |
pz. conf. 1 | c/c 12



€ 6,63

T8019.Z | vassoio nero | black tray | cm 30x20x2 |
pz. conf. 1 | c/c 12



€ 6,63

T8019 | vassoio bianco | white tray | cm 30x20x2 |
pz. conf. 1 | c/c 12





€ 17,08

T0553 | coperchio rotondo | round cover |
cm Ø 30,5x14 | pz. conf. 1 | c/c 12



€ 9,99

S5073 | coperchio rotondo | round cover |
cm Ø 28x14,5 | pz. conf. 1 | c/c 6



€ 25,91

T8154.L | tortiera bianca | white cake holder
cm Ø 35x10 | pz. conf. 1 | c/c 6



€ 17,69

T8154 | tortiera bianca | white cake holder |
cm Ø 30x10 | pz. conf. 1 | c/c 6





€ 11,64

T8525.Y | vassoio bigné | bigné tray
cm 32,5x26,5 | pz. conf. 1 | c/c 12



€ 9,08

T8524.Y | vassoio bigné | bigné tray
cm 31x20,5 | pz. conf. 1 | c/c 12



€ 4,73

T8521.Y | vassoio bigné | bigné tray
cm 26,5x16,2 | pz. conf. 1 | c/c 24



€ 3,11

T8522.Y | vassoio bigné | bigné tray
cm 17,5x11 | pz. conf. 1 | c/c 36





€ 5,13

T8418 | vassoio quadrato | square tray
cm 20x20x2,4 | pz. conf. 1 | c/c 48



€ 16,17

T8016 | 800g
vassoio rettangolare | rectangular tray
cm 48x30x2,5 | pz. conf. 1 | c/c 12



€ 11,74

T8417.Z | vassoio quadrato | square tray
cm 30x30x2,5 | pz. conf. 1 | c/c 12



€ 11,74

T8417 | vassoio quadrato | square tray
cm 30x30x2,5 | pz. conf. 1 | c/c 12



€ 16,17

T8016.Z | 800g
vassoio rettangolare | rectangular tray
cm 48x30x2,5 | pz. conf. 1 | c/c 12



€ 38,88

T8416 | 2100g
vassoio rettangolare | rectangular tray
cm 53x32x2,5 | pz. conf. 1 | c/c 6



€ 38,88

T8416.Z | 2100g
vassoio rettangolare | rectangular tray
cm 53x32x2,5 | pz. conf. 1 | c/c 6



€ 55,26

T8415 | vassoio rettangolare | rectangular tray |
cm 65x45x2,5 | pz. conf. 1 | c/c 4





T8433 | vassoio rettangolare | rectangular tray |
cm 26x16x1,5 | pz. conf. 1 | c/c 12

€ 4,20



T8430 | vassoio rettangolare | rectangular tray |
cm 32x17x1,5 | pz. conf. 1 | c/c 18

€ 10,07



T8431 | vassoio rettangolare | rectangular tray |
cm 26x32x1,5 | pz. conf. 1 | c/c 12

€ 14,82



T8432 | vassoio rettangolare | rectangular tray |
cm 53x32x1,5 | pz. conf. 1 | c/c 6

€ 25,21



T8434 | vassoio rettangolare | rectangular tray |
cm 53x16x1,5 | pz. conf. 1 | c/c 6

€ 14,46





€ 11,14

T8425 | vassoio quadrato | square tray |
cm 30x30x1,5 | pz. conf. 1 | c/c 16



€ 15,14

T8424 | vassoio quadrato | square tray |
cm 40x40x1,5 | pz. conf. 1 | c/c 12



€ 11,14

T8421 | vassoio rettangolare | rectangular tray | cm
32x26x1,5 | pz. conf. 1 | c/c 16



€ 22,28

T8420 | vassoio rettangolare | rectangular tray | cm
53x32x1,5 | pz. conf. 1 | c/c 8



€ 7,46

T8423 | vassoio quadrato | square tray |
cm 20x20x1,5 | pz. conf. 1 | c/c 24



€ 7,46

T8422 | vassoio rettangolare | rectangular tray | cm
26x16x1,5 | pz. conf. 1 | c/c 24



€ 27,90

T8437 | vassoio rettangolare | rectangular tray |
cm 65x45x1,5 | pz. conf. 1 | c/c 4



SNOW



€ 9,72

T8440 | insalatiera quadrata | square bowl | cm 17,7x17,7x8,3 | pz. conf. 1 | c/c 24



€ 9,72

T8440.Z | insalatiera quadrata | square bowl | cm 17,7x17,7x8,3 | pz. conf. 1 | c/c 24



€ 7,59

T8443 | ciotola inclinata | sloping bowl | cm 17,8x6,6x11,5 | pz. conf. 1 | c/c 18



€ 17,93

T8441 | insalatiera quadrata | square bowl | cm 24x24x10 | pz. conf. 1 | c/c 12



€ 17,93

T8441.Z | insalatiera quadrata | square bowl | cm 24x24x10 | pz. conf. 1 | c/c 12



€ 13,68

T8444 | ciotola inclinata | sloping bowl | cm 20,3x7,5x13 | pz. conf. 1 | c/c 12



€ 28,88

T8442 | insalatiera quadrata | square bowl | cm 30x30x11,5 | pz. conf. 1 | c/c 6



€ 28,88

T8442.Z | insalatiera quadrata | square bowl | cm 30x30x11,5 | pz. conf. 1 | c/c 6



€ 29,81

T8445 | ciotola inclinata | sloping bowl | cm 27,4x18x10 | pz. conf. 1 | c/c 6







€ 13,05

T8450 | vassoio | tray
GN 1/3 | h 3cm | pz. conf. 1 | c/c 18



€ 16,97

T8451 | vassoio | tray
GN 1/3 | h 6cm | pz. conf. 1 | c/c 10



€ 18,00

T8452 | vassoio | tray
GN 1/2 | h 3cm | pz. conf. 1 | c/c 12



€ 23,40

T8453 | vassoio | tray
GN 1/2 | h 6cm | pz. conf. 1 | c/c 8



€ 21,60

T8454 | vassoio | tray
GN 2/4 | h 3cm | pz. conf. 1 | c/c 12



€ 28,08

T8455 | vassoio | tray
GN 2/4 | h 6cm | pz. conf. 1 | c/c 8



€ 36,14

T8456 | vassoio | tray
GN 1/1 | h 3cm | pz. conf. 1 | c/c 6



€ 46,98

T8457 | vassoio | tray
GN 1/1 | h 6cm | pz. conf. 1 | c/c 4



VENEZIA



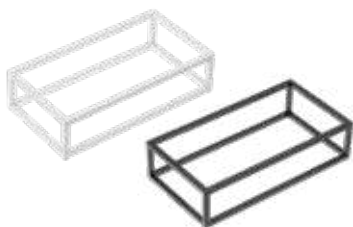

€ 27,32

T0580.Y

T0580.Z

stand buffet in metallo | metal buffet stand
GN 1/3 h8 cm | pz. conf. 1 | c/c 4

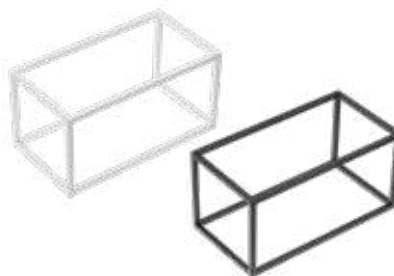

€ 27,72

T0581.Y

T0581.Z

stand buffet in metallo | metal buffet stand
GN 1/3 h16 cm | pz. conf. 1 | c/c 4

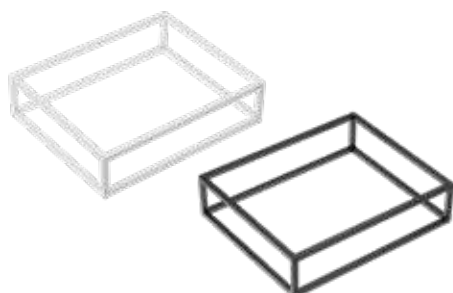

€ 29,48

T0582.Y

T0582.Z

stand buffet in metallo | metal buffet stand
GN 1/2 h8 cm | pz. conf. 1 | c/c 4

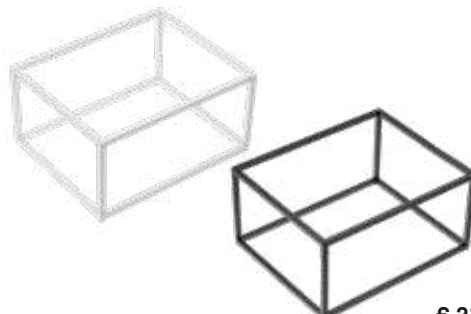

€ 31,50

T0583.Y

T0583.Z

stand buffet in metallo | metal buffet stand
GN 1/2 h16 cm | pz. conf. 1 | c/c 4

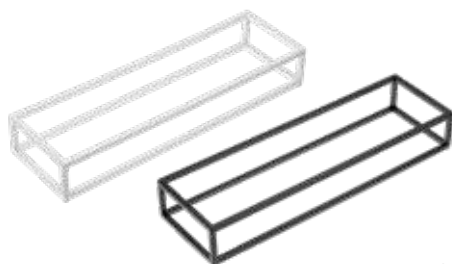

€ 29,66

T0584.Y

T0584.Z

stand buffet in metallo | metal buffet stand
GN 2/4 h8 cm | pz. conf. 1 | c/c 4

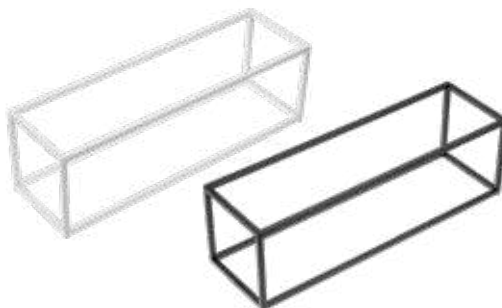

€ 30,20

T0585.Y

T0585.Z

stand buffet in metallo | metal buffet stand
GN 2/4 h16 cm | pz. conf. 1 | c/c 4

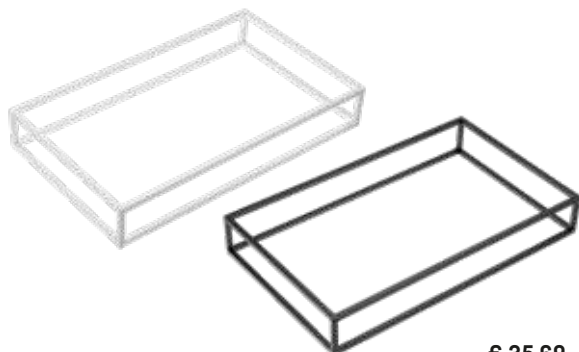

€ 35,69

T0586.Y

T0586.Z

stand buffet in metallo | metal buffet stand
GN 1/1 h8 cm | pz. conf. 1 | c/c 4

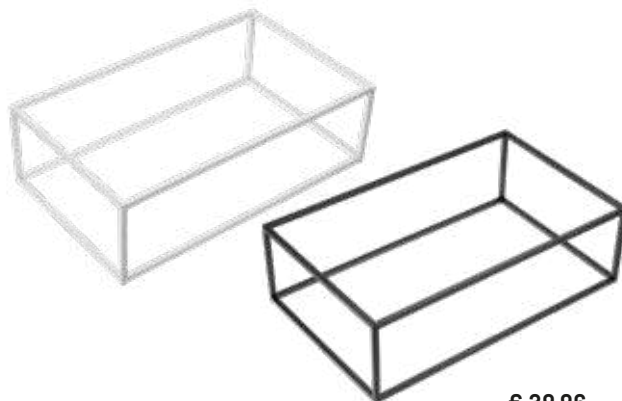

€ 39,96

T0587.Y

T0587.Z

stand buffet in metallo | metal buffet stand
GN 1/1 h16 cm | pz. conf. 1 | c/c 2







€ 31,19

T8465 | pirofila rettangolare | rectangular tray
cm 53x16,2x8 | pz. conf. 1 | c/c 6



€ 21,83

T8464 | pirofila rettangolare | rectangular tray
cm 32,5x17,6x8 | pz. conf. 1 | c/c 6



€ 10,70

T8404 | vassoio rettangolare | rectangular tray
cm 25x15x7,5 | pz. conf. 1 | c/c 12



€ 24,17

T8401 | vassoio rettangolare | rectangular tray
cm 50x20x7,5 | pz. conf. 1 | c/c 6



€ 23,80

T8403 | vassoio rettangolare | rectangular tray
cm 25x35x7,5 | pz. conf. 1 | c/c 6



€ 25,51

T8402 | vassoio rettangolare | rectangular tray
cm 45x30x7,5 | pz. conf. 1 | c/c 12



PIROFILE





€ 79,00

T8288 | set alzata 3 piatti | riser 3 plates
cm Ø 20/25/32x47 | pz. conf. 1 | c/c 3



€ 79,00

T8471 | set alzata 3 piatti | riser 3 plates
cm Ø 20/25/32x47 | pz. conf. 1 | c/c 3



€ 98,00

T8470 | set alzata con 3 piatti | riser with 3 plates
cm Ø 27x40 | pz. conf. 1 | c/c 2



ALZATE





€ 12,87

T8282 | griglia scolaghiaccio | ice grid
cm Ø 31,3 | pz. conf. 1 | c/c 6



€ 7,43

T8280 | griglia scolaghiaccio | ice grid
cm Ø 23,8 | pz. conf. 1 | c/c 8



€ 36,68

T8281 | piatto tondo | round plate
cm Ø 34x5,3 | pz. conf. 1 | c/c 6



€ 26,78

T8279 | piatto tondo | round plate
cm Ø 27x5,3 | pz. conf. 1 | c/c 8



€ 24,49

T0578 | stand nero | black stand
cm Ø 30x15,8 | pz. conf. 1 | c/c 4



€ 10,80

T8278 | base | riser
cm 16,2x12 | pz. conf. 1 | c/c 12



€ 111,95

T8277 | set 2 piatti completo | stand 2 plates
cm Ø 27/34x36 | pz. conf. 1 | c/c 1







€ 32,10

T8463 | vassoio rettangolare | rectangular tray |
cm 66x14,5x2 | pz. conf. 1 | c/c 4



€ 19,00

T8348 | vassoio foglia | leaf tray |
cm 37,5x15x2,2 | pz. conf. 1 | c/c 12



€ 37,74

T8462 | vassoio rettangolare | rectangular tray |
cm 66x14,5x2 | pz. conf. 1 | c/c 4



€ 35,00

T8349 | vassoio foglia | leaf tray |
cm 57x20x2,2 | pz. conf. 1 | c/c 6



€ 41,97

T8461 | vassoio rettangolare | rectangular tray |
cm 85x14,5x2 | pz. conf. 1 | c/c 4



€ 79,00

T8350 | vassoio foglia | leaf tray |
cm 84x25x3 | pz. conf. 1 | c/c 2



€ 49,35

T8460 | vassoio rettangolare | rectangular tray |
cm 85x14,5x2 | pz. conf. 1 | c/c 4



€ 16,38

T8153 | vassoio rettang. | rectangular tray |
cm 57x17x2,5 | pz. conf. 1 | c/c 6



LEAF





€ 2,34

T8207 | coppetta nera | black cup
cm 13x11x3,5 | pz. conf. 1 | c/c 48



€ 4,79

T8204 | vassoio 3 scomparti | 3 compartments tray |
cm 27x9x3,5 | pz. conf. 1 | c/c 24



€ 4,12

T8201 | coppetta nera | black small cup
cm 18x15x5,5 | pz. conf. 1 | c/c 48



€ 2,23

T8221 | ciotola stone | stone bowl
cm 14x8x2,5 | pz. conf. 1 | c/c 48



€ 2,46

T8206 | coppetta ovale | oval cup
cm 18x10x3,5 | pz. conf. 1 | c/c 48



€ 5,85

T8220 | ciotola stone | stone bowl
cm 22x14,7x4,7 | pz. conf. 1 | c/c 24



€ 3,63

T8227 | piatto ovale | oval dish
cm 25x13,6x4,3 | pz. conf. 1 | c/c 24



€ 4,46

T8213 | piatto stone | stone tray
cm 20x8,5x3 | pz. conf. 1 | c/c 36



€ 7,02

T8205 | piatto ovale | oval plate
cm 31x16x4 | pz. conf. 1 | c/c 24



€ 6,85

T8214 | piatto stone | stone tray
cm 34x10,5x3 | pz. conf. 1 | c/c 24





BLACK



€ 6,68

T8226 | vassoio rettangolare | rectangular tray |
cm 24x13,8x2,1 | pz. conf. 1 | c/c 24



€ 12,92

T8210 | vassoio rettangolare | rectangular tray |
cm 30x21x3 | pz. conf. 1 | c/c 12



€ 4,51

T8258 | foglia nera | black leaf shaped tray
cm 41x9,5x3 | pz. conf. 1 | c/c 24



€ 7,13

T8224 | vassoio foglia nera | black leaf tray
cm 36,5x15,5x2,7 | pz. conf. 1 | c/c 36



€ 8,02

T8209 | piatto piano | flat dish
cm Ø 28x3 | pz. conf. 1 | c/c 24



€ 8,42

T8228 | ciotola nera | black bowl
cm Ø19x9 | pz. conf. 1 | c/c 24





€ 3,23

T8215 | coppetta rettangolare | rectangular cup |
cm 10,6x9,6x5 | pz. conf. 1 | c/c 48



€ 2,62

T8203 | coppetta quadrata | square cup |
cm 7x7x6 | pz. conf. 1 | c/c 48



€ 2,67

T8270 | ciotolina nera | black small bowl
cm Ø7,8x5,8 | pz. conf. 1 | c/c 48



€ 1,95

T8202 | piattino nero | black small plate
cm 9x7x3 | pz. conf. 1 | c/c 48



€ 3,11

T8208 | coppetta tonda | round cup
cm Ø 12x5,3 | pz. conf. 1 | c/c 48



€ 2,90

T8222 | ciotola tonda | round cup
cm Ø 11,4x5,8 | pz. conf. 1 | c/c 48





€ 1,15

T8181.Z | coppetta nera | black bowl
cm Ø9x24 | pz. conf. 1 | c/c 84



€ 1,35

T8260 | ciotola tonda | round bowl
cm Ø7,6x2,7 | pz. conf. 1 | c/c 72



€ 2,26

T8261 | ciotola tonda | round bowl
cm Ø10x3,5 | pz. conf. 1 | c/c 48



€ 3,99

T8262 | ciotola tonda | round bowl
cm Ø12,7x4,5 | pz. conf. 1 | c/c 36



€ 5,37

T8263 | ciotola tonda | round bowl
cm Ø15,4x5,3 | pz. conf. 1 | c/c 24



€ 9,53

T8269 | ciotola inclinata | sloping bowl
cm Ø17,5x12,2 | pz. conf. 1 | c/c 12





€ 4,90

T8223 | pentolino | small pan
cm Ø 15x5,7 | pz. conf. 1 | c/c 36



€ 5,55

T8216 | padellino | small pan
cm Ø 15,5x3,5 | pz. conf. 1 | c/c 36



€ 5,89

T8523.Z | casseruola nera | black mini pan
cm 10,2x6,8 | pz. conf. 1 | c/c 32



€ 8,19

T8219 | padellino | small pan
cm Ø 19,5x3,7 | pz. conf. 1 | c/c 24



€ 5,46

T8257 | mini wok | mini wok
cm Ø 20x 2,5 | pz. conf. 1 | c/c 24



€ 11,41

T8256 | padellino nero | black small pan
cm Ø 24x 4 | pz. conf. 1 | c/c 24





€ 3,88

T8271 | vassoio quadrato | black square tray
cm 15x15x2 | pz. conf. 1 | c/c 36



€ 4,88

T8268 | vassoio ovale | oval tray
cm 26,2x12,8x1,8 | pz. conf. 1 | c/c 24



€ 5,30

T8272 | vassoio quadrato | black square tray |
cm 18x18x2 | pz. conf. 1 | c/c 24



€ 5,57

T8265 | vassoio rettangolare | rectangular tray |
cm 29x13,5x2 | pz. conf. 1 | c/c 18



€ 6,03

T8273 | vassoio quadrato | black square tray |
cm 21x21x2 | pz. conf. 1 | c/c 18



€ 7,29

T8264 | vassoio rettangolare | rectangular tray |
cm 32,6x15x2 | pz. conf. 1 | c/c 18



€ 14,68

T8266 | vassoio rettangolare | rectangular tray |
cm 60x20x2,5 | pz. conf. 1 | c/c 6



€ 12,35

T8267 | vassoio rettangolare | rectangular tray |
cm 53x16,2x2,5 | pz. conf. 1 | c/c 12



LANZAROTE





€ 16,23

T8250 | piatto tondo | round plate
cm Ø 31,2x8,5 | pz. conf. 1 | c/c 12



€ 11,23

T8251 | vassoio tondo | round tray
cm Ø 34,6x3,3 | pz. conf. 1 | c/c 16



€ 15,27

T8253 | vassoio tondo | round tray
cm Ø 39,7x3,4 | pz. conf. 1 | c/c 12



€ 25,87

T8254 | vassoio rettangolare | rectangular tray |
cm 40,5x26x3,8 | pz. conf. 1 | c/c 8



€ 32,21

T8255 | vassoio quadrato | square tray
cm 40x40x3,8 | pz. conf. 1 | c/c 6



MAYA





€ 12,65

T8117 | supporto per bacchette | chopsticks holder |
cm 5 | pz. conf. 10 | c/c 24



€ 10,71

T8116.Z | bacchette nere | black chopsticks
cm 27 | pz. conf. 10 paia | c/c 20



€ 6,40

T8274 | vassoio sushi nero | black sushi tray
cm 20,8x12x2,3 | pz. conf. 1 | c/c 24



€ 12,24

T8275 | vassoio sushi nero | black sushi tray
cm 27x18x2,3 | pz. conf. 1 | c/c 12



€ 15,56

T8276 | vassoio sushi nero | black sushi tray
cm 33x19x24 | pz. conf. 1 | c/c 8



SUSHI





€ 8,91

T8243 | vassoio rettangolare | rectangular tray |
cm 26x16 | pz. conf. 1 | c/c 20



€ 16,71

T8240 | vassoio tondo | round tray | cm Ø 30 |
pz. conf. 1 | c/c 10



€ 17,82

T8242 | vassoio rettangolare | rectangular tray |
cm 38x26 | pz. conf. 1 | c/c 10



€ 16,55

T8211 | vassoio quadrato | square tray |
cm 25x25x2 | pz. conf. 1 | c/c 12



€ 16,71

T8241 | vassoio quadrato | square tray | cm 30x30 |
pz. conf. 1 | c/c 10



€ 15,60

T8225 | vassoio rettangolare | rectangular tray |
cm 40x15x1,8 | pz. conf. 1 | c/c 12



€ 36,21

T8212 | vassoio rettangolare | rectangular tray |
cm 50x25x2 | pz. conf. 1 | c/c 6





€ 10,52

T8323 | vassoio rettangolare | rectangular tray |
cm 16x26x1,5 | pz. conf. 1 | c/c 12



€ 12,15

T8320 | vassoio rettangolare | rectangular tray |
cm 32x17x1,5 | pz. conf. 1 | c/c 18



€ 17,71

T8321 | vassoio rettangolare | rectangular tray |
cm 32x26x1,5 | pz. conf. 1 | c/c 12



€ 21,06

T8324 | vassoio rettangolare | rectangular tray |
cm 16x53x1,5 | pz. conf. 1 | c/c 6



€ 35,54

T8322 | vassoio rettangolare | rectangular tray |
cm 53x32x1,5 | pz. conf. 1 | c/c 6

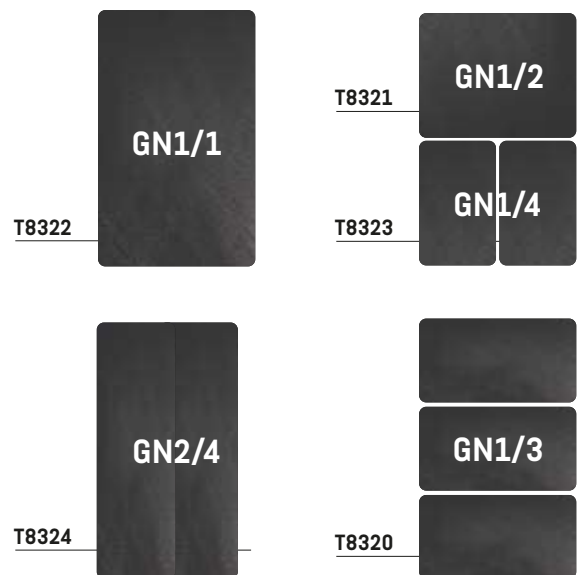



€ 1,51

T8552 | ciotolina quadrata | square bowl
cm 6,5x6,5x2,8 | pz. conf. 1 | c/c 72



€ 2,37

T8553 | bis ciotoline quadrate | square bowl set |
cm 11,5x6,5x2,8 | pz. conf. 1 | c/c 48



€ 3,32

T8554 | tris ciotoline quadrate | square bowl set |
cm 17,5x6,5x2,8 | pz. conf. 1 | c/c 36



€ 4,52

T8555 | vassoio rettangolare | rectangular tray |
cm 19x12,3x2 | pz. conf. 1 | c/c 36



€ 6,11

T8556 | vassoio rettangolare | rectangular tray |
cm 25x12,2x2 | pz. conf. 1 | c/c 24





€ 1,74

T8550 | ciotolina | small bowl
cm Ø7,6x2,7 | pz. conf. 1 | c/c 72



€ 3,01

T8557 | ciotola | bowl
cm Ø11,5x5,5 | pz. conf. 1 | c/c 36



€ 4,33

T8551 | ciotola | bowl
cm Ø12,7x4,5 | pz. conf. 1 | c/c 36



€ 6,67

T8558 | ciotola | bowl
cm Ø16,7x7,7 | pz. conf. 1 | c/c 24





€ 23,40

U0013 | ciotola tonda | round bowl
cm Ø15x5,5 | pz. conf. 4 | c/c 3



€ 36,00

U0014 | ciotola tonda | round bowl
cm Ø21,5x6,5 | pz. conf. 4 | c/c 3



€ 29,70

U0011 | piatto rotondo | round plate
cm Ø21,5x3,5 | pz. conf. 4 | c/c 3



€ 36,00

U0012 | piatto rotondo | round plate
cm Ø26,5x4 | pz. conf. 4 | c/c 3



ZANZIBAR





€ 10,80

U0015 | ciotola | bowl
cm Ø8x3,6 | pz. conf. 6 | c/c 8



€ 14,85

U0018 | piattino | small plate
cm Ø14x3 | pz. conf. 6 | c/c 8



€ 15,66

U0016 | ciotola | bowl
cm Ø12x6 | pz. conf. 6 | c/c 4



€ 18,90

U0017 | ciotola | bowl
cm Ø14x6 | pz. conf. 6 | c/c 4



LUXOR



€ 8,10

U0019 | ciotolina grigia | grey bowl
cm Ø 8x2,5 | pz. conf. 6 | c/c 4



€ 14,85

U0022 | ciotolina tortora | dove grey bowl
cm Ø 12,8x10,6x4,6 | pz. conf. 6 | c/c 4



€ 18,36

U0023 | ciotola grigia | grey bowl
cm Ø 15,6x12,6x5,2 | pz. conf. 6 | c/c 4



€ 12,96

U0020 | ciotolina tortora | dove grey bowl
cm Ø 13,4x3,5 | pz. conf. 6 | c/c 4



€ 14,85

U0021 | ciotola grigia | grey bowl
cm Ø 10,5x5,5 | pz. conf. 6 | c/c 8



DUBAI



HOKKAIDO





€ 10,26

U0035 | ciotola ovale | oval bowl
cm 9,5x6,2x2,5 | pz. conf. 6 | c/c 8



€ 10,26

U0034 | ciotolina | small bowl
cm Ø 9x2,2 | pz. conf. 6 | c/c 8



€ 35,10

U0031 | vassoio con manici | tray with handles
cm 18,5x15x4 | pz. conf. 6 | c/c 4



€ 32,40

U0032 | vassoio rettangolare | rectangular tray
cm 19,5x12,5x2 | pz. conf. 6 | c/c 4



€ 45,36

U0033 | ciotola con manici | bowl with handles
cm 22x17,8x4 | pz. conf. 6 | c/c 4





€ 9,45

U0036.T | teiera grigia | grey teapot |
cm 17,5x8,8x11 | pz. conf. 1 | c/c 8



€ 9,00

U0036.Y | teiera bianca | white teapot |
cm 17,5x8,8x11 | pz. conf. 1 | c/c 8



€ 21,06

U0037.T | tazza grigia | grey mug |
cm Ø 8,5x10 | pz. conf. 6 | c/c 4



€ 20,25

U0037.Y | tazza bianca | white mug |
cm Ø 8,5x10 | pz. conf. 6 | c/c 4



€ 10,80

U0024.T | bicchiere grigio |
grey glass | cm Ø 6x6
pz. conf. 6 | c/c 4



€ 10,80

U0024.U | bicchiere tortora |
dove grey glass | cm Ø 6x6
pz. conf. 6 | c/c 4



€ 10,80

U0024.Y | bicchiere bianco |
white glass | cm Ø 6x6
pz. conf. 6 | c/c 4



HOKKAIDO





€ 9,45

U0025 | ciotola tonda | round bowl |
cm Ø 9x2,5 | pz. conf. 6 | c/c 4



€ 14,85

U0027 | ciotola quadrata | square bowl |
cm 9,5x9,5x4 | pz. conf. 6 | c/c 4



€ 17,55

U0026 | ciotola tonda | round bowl |
cm Ø 12x3,5 | pz. conf. 6 | c/c 4



€ 18,09

U0028 | ciotola quadrata | square bowl |
cm 12x12x4,7 | pz. conf. 6 | c/c 4



€ 18,36

U0029 | piatto quadrato | square plate |
cm 12x12x2 | pz. conf. 6 | c/c 4



€ 29,70

U0030 | vassoio rettangolare | rectangular tray |
cm 20,5x11x2 | pz. conf. 6 | c/c 4



AMALFI



€ 33,26

S6000 | tagliere | cutting board |
cm 35x17x2 | pz. conf. 1 | c/c 4

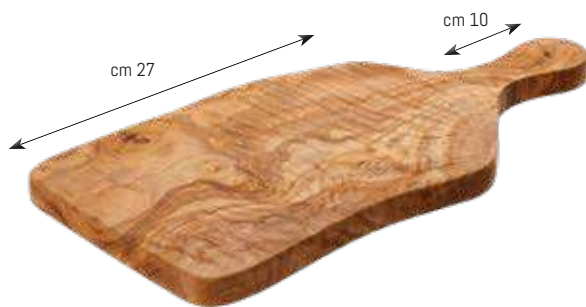

€ 34,47

S6002 | tagliere | cutting board |
cm 37x17x2 | pz. conf. 1 | c/c 4



€ 27,86

S6003 | vassoio rettangolare | rectangular tray |
cm 20x12x2 | pz. conf. 1 | c/c 4

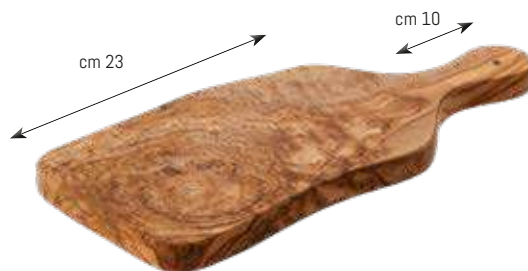

€ 30,06

S6001 | tagliere | cutting board |
cm 33x14x2 | pz. conf. 1 | c/c 4





€ 22,14

S6005 | ciotola tonda | round bowl |
cm Ø 12x5 | pz. conf. 1 | c/c 8



€ 42,66

S6004 | vassoio 3 scomparti | 3 compartment tray |
cm 30x15x3,5 | pz. conf. 1 | c/c 4



€ 61,92

S6007 | ciotola tonda | round bowl |
cm Ø 18x7 | pz. conf. 1 | c/c 4



€ 30,33

S6006 | ciotola tonda | round bowl |
cm Ø 15x6 | pz. conf. 1 | c/c 6



OLIVE WOOD



€ 37,01

S5054 | stand in acacia e ardesia | acacia stand |
cm 39,5x25x39,5 | pz. conf. 1 | c/c 3



€ 46,57

S5051 | set alzata buffet acacia | acacia display set
cm 45x20x40 | pz. conf. 1 | c/c 2



€ 24,44

S5069 | set alzata a buffet | acacia display set |
cm 37x18x30 | pz. conf. 1 | c/c 6



€ 56,02

S5052 | set alzata buffet acacia | acacia display set
cm 65x20x40 | pz. conf. 1 | c/c 2



€ 40,98

S5070 | set alzata 3 ripiani | acacia buffet set |
cm 35x42x23 | pz. conf. 1 | c/c 6



€ 126,50

S5068 | stand buffet in acacia 3 scomparti | acacia
buffet stand 3 compartments | pz. conf. 1 | c/c 2



€ 56,02

S5050 | set espositori 3 pz. | 3 pcs acacia display |
cm 13/18/23 | pz. conf. set 3 pz. | c/c 2



€ 102,58

S5049 | set espositori 3 pz. | 3 pcs acacia display |
cm 60/45/30x30 | pz. conf. set 3 pz. | c/c 2





WOOD STAND



€ 13,77

S5055 | disco buffet in acacia | acacia buffet disk |
cm Ø 28x2 | pz. conf. 1 | c/c 6



€ 16,80

S5056 | disco buffet in acacia | acacia buffet disk |
cm Ø 33x2 | pz. conf. 1 | c/c 6



€ 22,64

S5057 | disco buffet in acacia | acacia rectangular
tray | cm Ø 38x2 | pz. conf. 1 | c/c 6



€ 6,70

T0577 | supporto cromato | chromed stand
cm 28x20x20,5 | pz. conf. 1 | c/c 12





€ 14,48

T0574 | supporto gommato | coated stand
cm 26x26x10,5 | pz. conf. 1 | c/c 6



€ 10,71

T0576.S | supporto gommato | coated stand
cm 10x10 | pz. conf. 1 | c/c 6



€ 13,89

T0576.M | supporto gommato | coated stand
cm 15x15 | pz. conf. 1 | c/c 6



€ 11,35

T0575.M | supporto gommato | coated stand
cm 16,5x16,5x20 | pz. conf. 1 | c/c 6



€ 16,76

T0576.L | supporto gommato | coated stand
cm 20x20 | pz. conf. 1 | c/c 6



€ 12,21

T0575.L | supporto gommato | coated stand
cm 20,5x20,5x20 | pz. conf. 1 | c/c 6





€ 29,34

S5031 | set 3 marmellatiere | 3 jam holder set |
cm 29,5x12,5x5 | pz. conf. 1 | c/c 5



€ 6,80

T3017 | vasetto con cucchiaino | bowl with spoon |
cm Ø 8x6 | pz. conf. 1 | c/c 18



€ 46,78

S5053 | set 3 porta cereali | 3 cereal holder set |
cm 40x14,5x11 | pz. conf. 1 | c/c 4



€ 13,77

S5026 | set 3 ciotole | 3 bowls set |
cm 31,5x11,5x4 | pz. conf. 1 | c/c 10





€ 13,54

S5041 | portatovaglioli | napkin holder
cm 14x14x10 | pz. conf. 1 | c/c 12



€ 16,80

S5040 | portatovaglioli | napkin holder
cm 18,6x18,6x10 | pz. conf. 1 | c/c 12



€ 30,81

S5042 | portabicchieri | glass holder
cm 23x12x30 | pz. conf. 1 | c/c 6



€ 18,21

S5043 | portabustine/posate | sachet/cutlery holder |
cm 16,5x27,5x6 | pz. conf. 1 | c/c 8





€ 10,65

S5021 | cassetina | wooden box
cm 16x11x11 | pz. conf. 1 | c/c 10



€ 17,97

S5022 | cassetina | wooden box
cm 23x15,5x12 | pz. conf. 1 | c/c 8



€ 24,27

S5023 | cassetina | wooden box
cm 26x15x11,7 | pz. conf. 1 | c/c 8



€ 14,00

S5005 | cassetina blackwood | blackwood box |
cm 33x13x7 | pz. conf. 1 | c/c 10



€ 22,41

S5044 | portaposate | cutlery holder
cm 15x15x15 | pz. conf. 1 | c/c 8



€ 20,54

S5006 | cassetina blackwood | blackwood box |
cm 35x24x6 | pz. conf. 1 | c/c 5



€ 18,21

S5025 | portabustine | sachet holder
cm 39x10,2x7,5 | pz. conf. 1 | c/c 4



€ 11,56

S5003 | cassetta quadrata | square wood box |
cm 20x20x7 | pz. conf. 1 | c/c 10



€ 22,88

S5024 | portabustine | sachet holder
cm 39x10,2x10 | pz. conf. 1 | c/c 4



€ 17,11

S5004 | cassetta rettangolare | rectang. wood box |
cm 32,5x26,5x7 | pz. conf. 1 | c/c 5



WOOD BOX



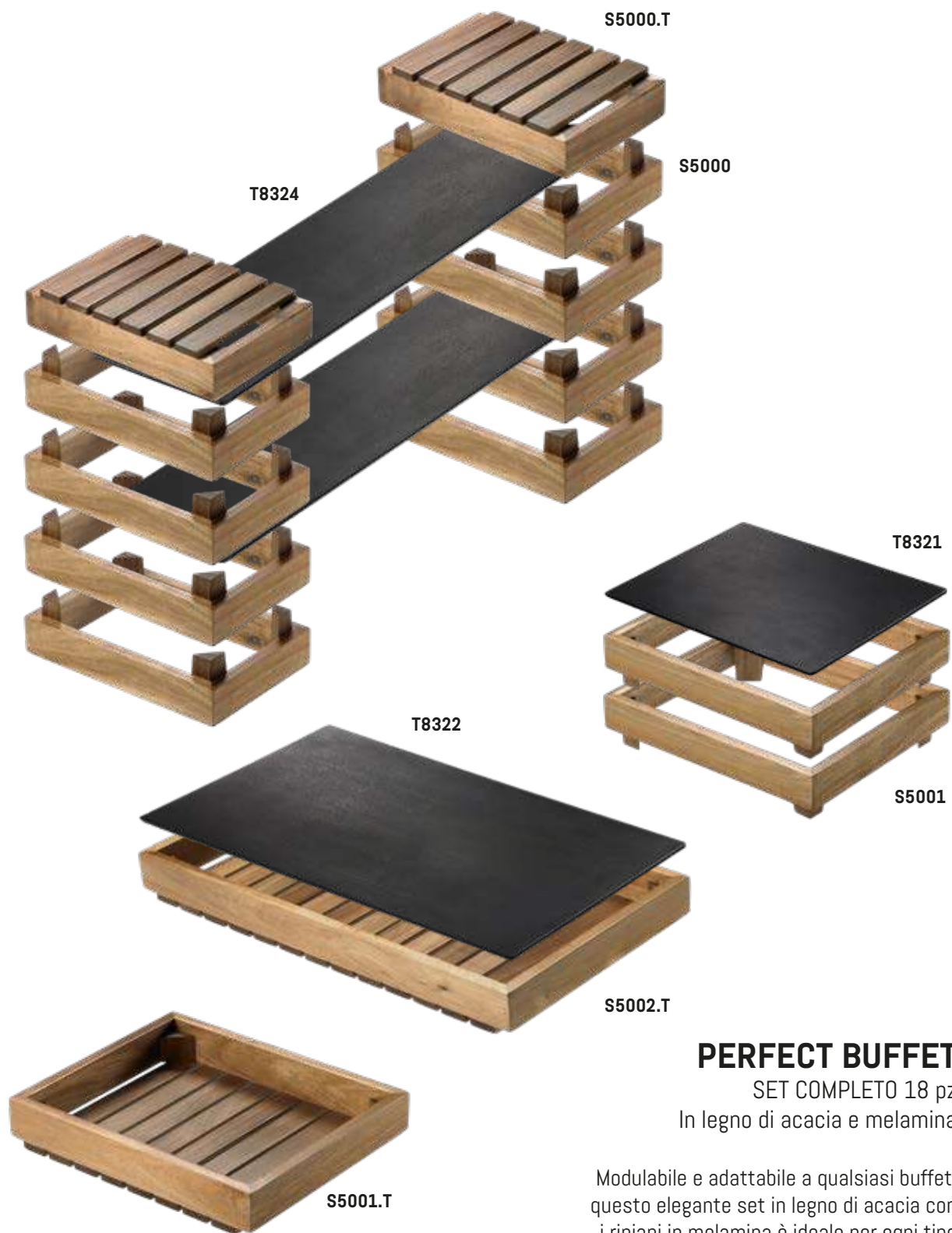

PERFECT BUFFET

SET COMPLETO 18 pz
In legno di acacia e melamina

Modulabile e adattabile a qualsiasi buffet, questo elegante set in legno di acacia con i ripiani in melamina è ideale per ogni tipo di presentazione, dalla colazione in B&B all'evento più raffinato.

Adjustable and adaptable to any kind of buffet, this elegant set in acacia wood with melamine shelves is ideal for all types of display, either for a breakfast in a B&B or for a more elegant party.

€ 264,16

S5102 | set perfect buffet | set perfect buffet
pz conf. 1 | c/c 1



PERFECT BUFFET





€ 11,91

S5000 | modulo aperto | open-component |
cm 30x19,5x7,7 | pz. conf. 1 | c/c 10



€ 9,99

S5073 | coperchio rotondo | round cover |
cm Ø 28x14,5 | pz. conf. 1 | c/c 6



€ 17,05

S5001 | modulo aperto | open-component |
cm 36x30x7,7 | pz. conf. 1 | c/c 5



€ 49,96

S5071 | tortiera in acacia | acacia cake holder
cm Ø 30x15 | pz. conf. 1 | c/c 2



€ 24,76

S5002 | modulo aperto | open-component |
cm 56,3x36x7,7 | pz. conf. 1 | c/c 5



€ 59,69

S5072 | tortiera in acacia | acacia cake holder
cm Ø 30x23 | pz. conf. 1 | c/c 2



€ 20,49

S5000.R | modulo contenitore | acacia container |
cm 30x19,5x11 | pz. conf. 1 | c/c 6



€ 17,27

S5000.T | modulo chiuso | closed-component |
cm 30x19,5x6 | pz. conf. 1 | c/c 10



€ 26,97

S5001.R | modulo contenitore | acacia container |
cm 36x30x11,5 | pz. conf. 1 | c/c 4



€ 20,54

S5001.T | modulo chiuso | closed-component |
cm 36x30x6 | pz. conf. 1 | c/c 5



€ 41,95

S5002.R | modulo contenitore | acacia container |
cm 56,3x36x11 | pz. conf. 1 | c/c 4



€ 28,83

S5002.T | modulo chiuso | closed-component |
cm 56,3x36x6 | pz. conf. 1 | c/c 5



ACACIA WOOD

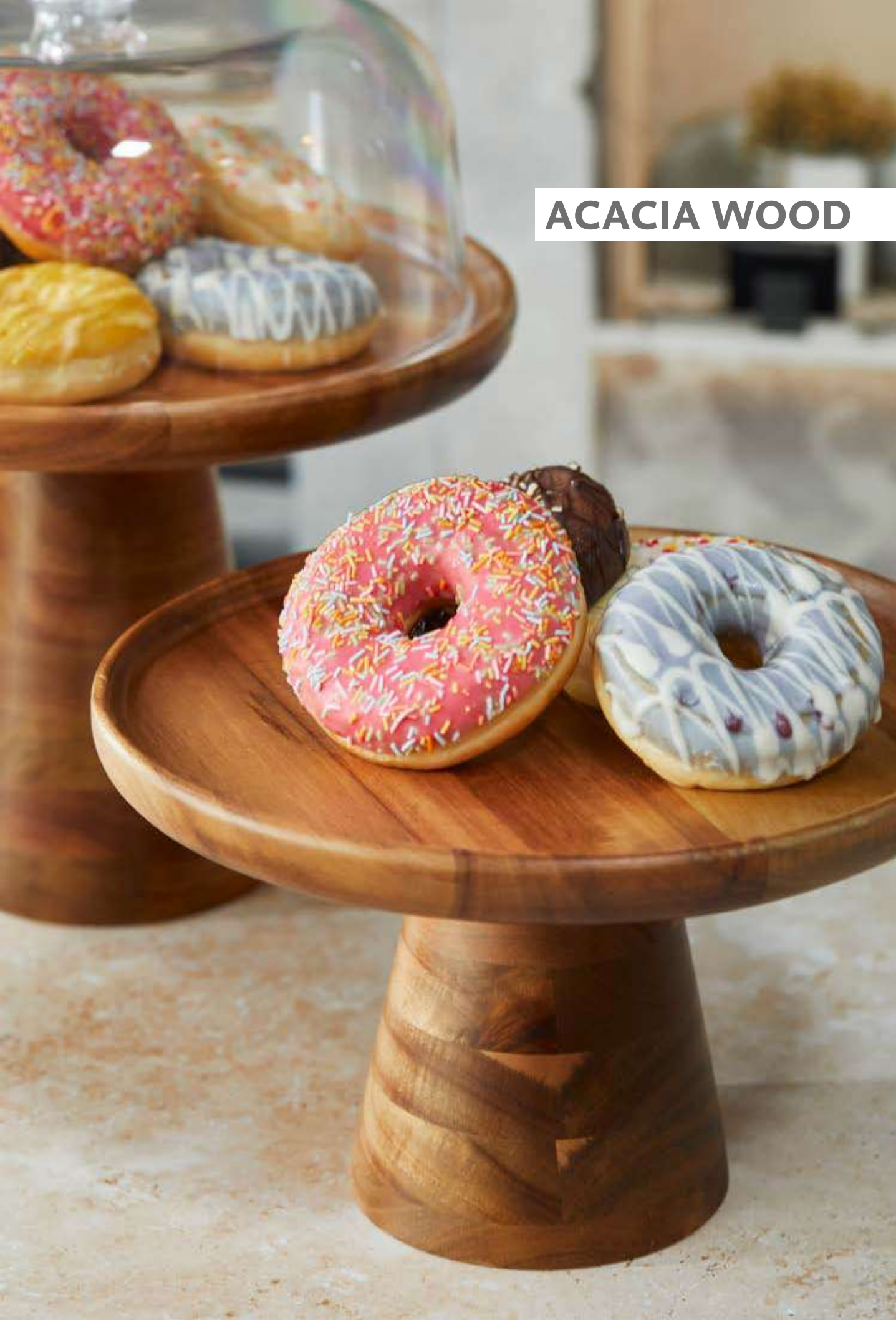



€ 31,90

T5056 | caraffa policarbonato | polycarb. pitcher |
lt. 2 | pz. conf. 1 | c/c 12



€ 10,40

T5052.C | coperchio per ciotola | bowl cover
cm Ø 23 | pz. conf. 1 | c/c 24



€ 5,24

T5002 | mattonella refrigerante | ice box
cm 20x17x3 - 850 ml | pz. conf. 1 | c/c 12



€ 10,40

T5052.P | ciotola in policarbonato | polycarbonate
bowl cm Ø 23 | pz. conf. 1 | c/c 24



€ 1,94

T5024 | mattonella refrigerante | freeze tile |
cm 13,5x12,5x14 | pz. conf. 1 | c/c 50



€ 1,61

T8138 | cucchiaino bianco | white spoon
cm 26,5 | pz. conf. 1 | c/c 48



€ 18,43

S5048 | supporto per caraffe | base for pitcher |
cm 20x20x8 | pz. conf. 1 | c/c 6



€ 28,94

S5047 | supporto per ciotole | base for bowl
cm 26x26x11 | pz. conf. 1 | c/c 6



€ 44,90

S5100 | set caraffa | pitcher set
pz. conf. 1 | c/c 1



€ 46,90

S5101 | set ciotola | bowl set
pz. conf. 1 | c/c 1





GN 1/1

€ 50,95

T0550 | coperchio apribile |
openable cover | cm 53x32,5x17,5 |
pz. conf. 1 | c/c 2



€ 5,20

T5106 | jelly bag caldo/freddo |
hot&cold jelly bag | cm 26x16 |
pz. conf. 1 | c/c 24



€ 39,50

T0551 | coperchio apribile |
openable cover | cm 42,5x29x15 |
pz. conf. 1 | c/c 2



GN 1/1

€ 19,40

T8061 | vassoio ambra | ambra tray
cm 53x32,5x2 | pz. conf. 1 | c/c 6



€ 14,16

T8063 | vassoio ambra | ambra tray
cm 41,5x28x2 | pz. conf. 1 | c/c 6



GN 1/1

€ 34,00

T8060 | vassoio ambra | ambra tray
cm 53x32,5x6 | pz. conf. 1 | c/c 6



€ 22,55

T8062 | vassoio ambra | ambra tray
cm 41,5x28x6 | pz. conf. 1 | c/c 6



GN 1/1

€ 43,63

S5045 | supporto per vassoio | stand for tray
cm 53,2x32,5x9 | pz. conf. 1 | c/c 4



€ 35,01

S5046 | supporto per vassoio | stand for tray
cm 42x28x9 | pz. conf. 1 | c/c 4



€ 111,90

S5103 | set espositore | acacia buffet set
cm 53,2x32,5x27 | pz. conf. 1 | c/c 1



€ 89,90

S5104 | set espositore | acacia buffet set
cm 42x28x27 | pz. conf. 1 | c/c 1





€ 10,13

S5065 | tagliere in acacia | acacia wood cutboard |
cm 32,5x21,5x2 | pz. conf. 1 | c/c 10



€ 8,82

S5064 | tagliere in acacia | acacia wood cutboard |
cm 32,5x17,5x2 | pz. conf. 1 | c/c 10



€ 16,61

S5067 | tagliere in acacia | acacia wood cutboard |
cm 40x30x2 | pz. conf. 1 | c/c 6



€ 11,93

S5066 | tagliere in acacia | acacia wood cutboard |
cm 32,5x26,5x2 | pz. conf. 1 | c/c 8



€ 19,14

S5034 | vassoio | wooden tray
cm 38x24x5 | pz. conf. 1 | c/c 6



€ 15,41

S5035 | vassoio | wooden tray
cm 20x30x5 | pz. conf. 1 | c/c 8





S5012 | tagliere | chopping board
cm 25x13x1,5 | pz. conf. 1 | c/c 10

€ 7,70

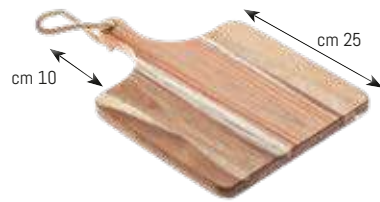

S5018 | tagliere | chopping board
cm 35x24,5x1,8 | pz. conf. 1 | c/c 10

€ 16,34

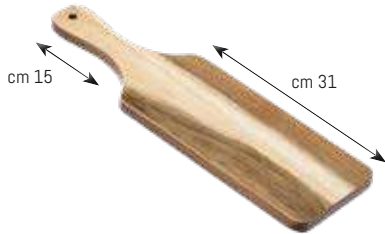

S5009 | tagliere | chopping board
cm 46x13x1,6 | pz. conf. 1 | c/c 8

€ 9,94

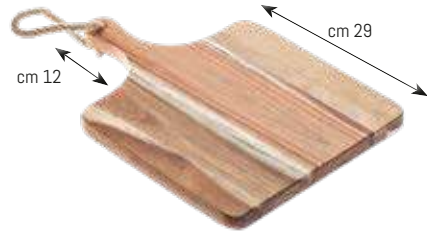

S5017 | tagliere | chopping board
cm 41x29,5x1,8 | pz. conf. 1 | c/c 10

€ 20,54



S5010 | tagliere | chopping board
cm 75x20x1,6 | pz. conf. 1 | c/c 5

€ 18,67



S5011 | tagliere | chopping board
cm 45x18x1,6 | pz. conf. 1 | c/c 5

€ 11,91





€ 14,23

S5028 | vassoio c/ciotola | tray with bowl
cm 25x20x1,5 | pz. conf. 1 | c/c 10



€ 9,36

S5059 | tagliere squadrondo | cutting board
cm 20x20x1,5 | pz. conf. 1 | c/c 10



€ 15,41

S5029 | vassoio c/ciotola | tray with bowl
cm 32x26x1,5 | pz. conf. 1 | c/c 10



€ 14,92

S5060 | tagliere squadrondo | cutting board
cm 30x30x1,5 | pz. conf. 1 | c/c 10



€ 14,93

S5027 | vassoio c/ciotola | tray with bowl
cm 45x13x4,5 | pz. conf. 1 | c/c 10



€ 26,10

S5061 | tagliere squadrondo | cutting board
cm 40x40x1,5 | pz. conf. 1 | c/c 6



€ 16,80

S5032 | vassoio c/ciotola | tray with bowl
cm 39,4x25x1,5 | pz. conf. 1 | c/c 10



€ 9,80

S5014 | piatto tondo | round dish
cm Ø 20x2 | pz. conf. 1 | c/c 20



€ 18,67

S5033 | vassoio c/ciotola | tray with bowl
cm 49,7x24,2x1,5 | pz. conf. 1 | c/c 10



€ 12,13

S5015 | piatto tondo | round dish
cm Ø 25x2 | pz. conf. 1 | c/c 10







€ 15,82

S5016 | vassoio | wooden tray
cm 60x12x3 | pz. conf. 1 | c/c 10



€ 14,71

S5013 | vassoio | wooden tray
cm 60x12,5x3 | pz. conf. 1 | cc 10



€ 15,68

S5062 | ciotola in acacia | acacia bowl
cm Ø 21x7 | pz. conf. 1 | c/c 5



€ 20,05

S5063 | ciotola in acacia | acacia bowl
cm Ø 25x9 | pz. conf. 1 | c/c 5



€ 29,98

S5030 | vassoio tondo | wooden round tray
cm Ø 35x7 | pz. conf. 1 | c/c 5



ACACIA TRAY





€ 14,01

S5081 | cassetta buffet | buffet box |
cm 32,5x17,5x5,6 | pz. conf. 1 | c/c 8



€ 16,12

S5082 | cassetta buffet | buffet box |
cm 32,5x26,5x5,6 | pz. conf. 1 | c/c 5



€ 18,19

S5080 | cassetta buffet | buffet box |
cm 53x16,2x5,6 | pz. conf. 1 | c/c 8



€ 25,38

S5083 | cassetta buffet | buffet box |
cm 53x32,5x5,6 | pz. conf. 1 | c/c 4





STACKABLE

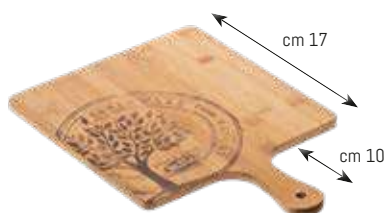

€ 4,73

S4108 | tagliere quadrato | square cutting board |
cm 17x17x1 | pz. conf. 1 | c/c 40



€ 5,74

S4100 | tagliere tondo | round cutting board
cm Ø 20x1 | pz. conf. 1 | c/c 30

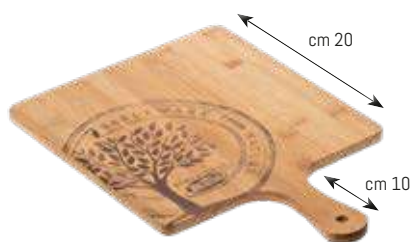

€ 5,58

S4109 | tagliere quadrato | square cutting board |
cm 20x20x1 | pz. conf. 1 | c/c 30



€ 8,30

S4101 | tagliere tondo | round cutting board
cm Ø 25x1 | pz. conf. 1 | c/c 25



€ 8,93

S4110 | tagliere quadrato | square cutting board |
cm 24x24x1 | pz. conf. 1 | c/c 25



€ 9,26

S4102 | tagliere tondo | round cutting board
cm Ø 30x1 | pz. conf. 1 | c/c 20 2



€ 9,94

S4111 | tagliere quadrato | square cutting board |
cm 30x30x1 | pz. conf. 1 | c/c 20



€ 11,74

S4103 | tagliere tondo | round cutting board
cm Ø 35x1 | pz. conf. 1 | c/c 15



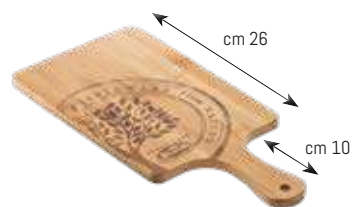

€ 5,27

S4104 | tagliere rettangolare | rectang. cutting board
cm 12x26x1 | pz. conf. 1 | c/c 40



€ 5,86

S4105 | tagliere rettangolare | rectang. cutting board
cm 15x30x1 | pz. conf. 1 | c/c 40

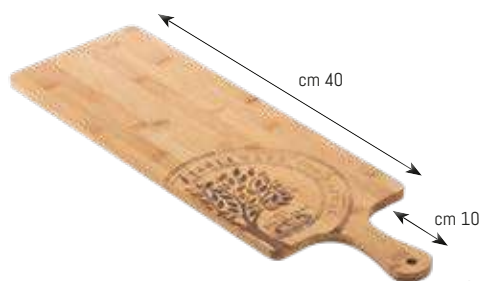

€ 7,07

S4106 | tagliere rettangolare | rectang. cutting board
cm 16x40x1 | pz. conf. 1 | c/c 25

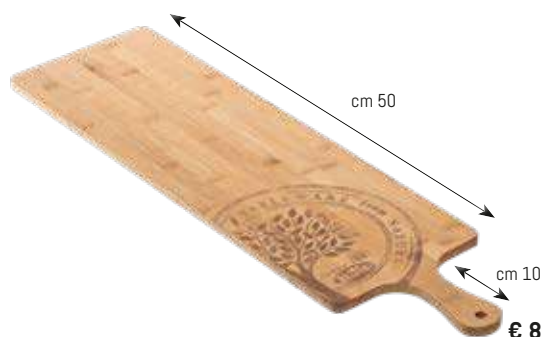

€ 8,42

S4107 | tagliere rettangolare | rectang. cutting board
cm 17x50x1 | pz. conf. 1 | c/c 20

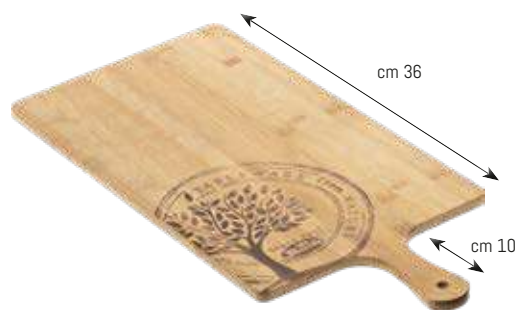

€ 7,85

S4115 | tagliere pinsa | "pinsa" cutting board |
cm 23x36x1 | pz. conf. 1 | c/c 20





€ 14,54

S0073 | tagliere rotondo | round cutting board
cm Ø 29x2,5 | pz. conf. 1 | c/c 12



€ 17,41

S0072 | tagliere rotondo | round cutting board
cm Ø 35x2,5 | pz. conf. 1 | c/c 12



€ 28,49

S0092 | tagliere girevole | turnable cutting board |
cm Ø 40 | pz. conf. 1 | c/c 6



€ 20,00

S0091 | piatto girevole | turnable cutting board |
cm Ø 32 | pz. conf. 1 | c/c 12



€ 25,33

S0074 | tagliere maxi | maxi tray
cm Ø 42x2,5 | pz. conf. 1 | c/c 6



€ 22,76

S0126 | tagliere India | India cutting board
cm 40x30x3 | pz. conf. 1 | c/c 6





€ 8,06

S4015 | vassoio quadrato | square tray
cm 22x22x1,7 | pz. conf. 1 | c/c 12



€ 16,13

S4000 | piatto c/portabicchiere | plate with cup holder
cm 18x15x0,8 | pz. conf. 6 | c/c 8



€ 8,49

S4017 | vassoio rettangolare | rectang. tray
cm 34x14x1,7 | pz. conf. 1 | c/c 12



€ 14,97

S4114 | vassoio Wave | Wave tray
cm 40x26x2,7 | pz. conf. 1 | c/c 8



€ 11,89

S4016 | vassoio tondo | round tray
cm Ø 27x1,7 | pz. conf. 1 | c/c 12



€ 12,01

S0083 | tagliere | cutting board
cm 45x28x1,6 | pz. conf. 1 | c/c 12





€ 14,86

S0094 | tagliere ovale | oval dish
cm 21x40x1,5 | pz. conf. 1 | c/c 12



€ 7,88

S0081 | tagliere bicolor | bicolor cutting board |
cm 22x30x1,9 | pz. conf. 1 | c/c 12

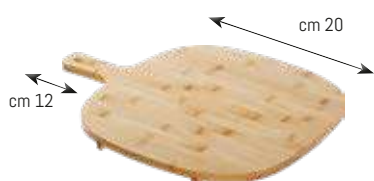

€ 7,41

S0111 | tagliere squadrondo | cutting board
cm 20x20x1,5 | pz. conf. 1 | c/c 24



€ 13,09

S0082 | tagliere bicolor | bicolor cutting board |
cm 40x30x1,9 | pz. conf. 1 | c/c 6

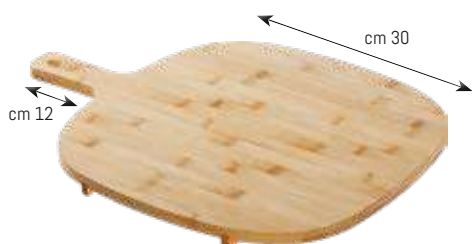

€ 15,26

S0112 | tagliere squadrondo | cutting board
cm 30x30x1,5 (manico 12) | pz. conf. 1 | c/c 12



€ 6,30

S0121 | tagliere Japan | Japan cutting board
cm 30x22x1 | pz. conf. 1 | c/c 12

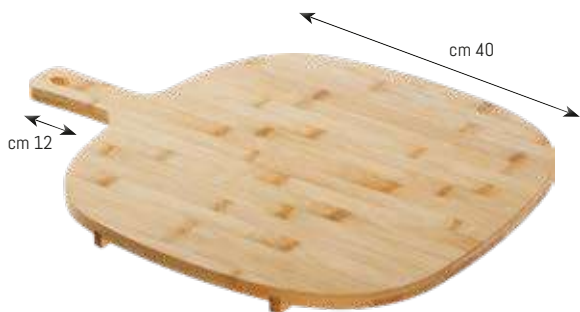

€ 21,47

S0113 | tagliere squadrondo | cutting board
cm 40x40x1,5 (manico 12) | pz. conf. 1 | c/c 6



€ 7,21

S0122 | tagliere Japan | Japan cutting board
cm 35x25x1 | pz. conf. 1 | c/c 6







€ 2,23

T8109 | coppetta bianca | white small cup
cm Ø 11x5,6 | pz. conf. 1 | c/c 48



€ 1,15

T8181.Z | coppetta nera | black bowl
cm Ø9x24 | pz. conf. 1 | c/c 84



€ 12,15

T8320 | vassoio rettangolare | rectangular tray | cm
32x17x1,5 | pz. conf. 1 | c/c 18



€ 23,47

S0102 | tagliere c/antibruciole | anti-crubs tray |
cm 40x24x4 | pz. conf. 1 | c/c 12



€ 17,25

S4005 | vassoio rettangolare | rectangular tray |
cm 43x20x24 | pz. conf. 1 | c/c 8



€ 23,47

S0103 | griglia per tagliere | chopping board
cm 53x32,5x1,6 | pz. conf. 1 | c/c 8



€ 30,80

S1005 | set hamburger | hamburger set
cm 43x20x24 | pz. conf. 1 | c/c 8



€ 43,49

S0100 | base Asia | base Asia
cm 53x32,5x9 | pz. conf. 1 | c/c 2



BAMBOO SET





SPECIAL PRICE

€ 5,95

S4011 | vassoio tondo | round tray
cm Ø 18,7x1,5 | pz. conf. 1 | c/c 18



€ 9,88

S4012 | vassoio tondo | round tray
cm Ø 24x1,5 | pz. conf. 1 | c/c 18



€ 11,91

S4013 | vassoio tondo | round tray
cm Ø 28x1,5 | pz. conf. 1 | c/c 12



€ 16,73

S4014 | vassoio tondo | round tray
cm Ø 33x1,5 | pz. conf. 1 | c/c 12



€ 6,92

S4007 | vassoio rettangolare | rectang. tray
cm 12x24x1,5 | pz. conf. 1 | c/c 24



€ 7,86

S4008 | vassoio rettangolare | rectang. tray
cm 24x16x1,5 | pz. conf. 1 | c/c 18



APERITIME





€ 5,57

S0123 | vassoio ovale | oval tray
cm 22x14x2 | pz. conf. 1 | c/c 24



€ 9,65

S0124 | vassoio ovale | oval tray
cm 28,5x21,5x2 | pz. conf. 1 | c/c 12



€ 14,80

S0125 | vassoio ovale | oval tray
cm 32x24x2 | pz. conf. 1 | c/c 6



€ 10,71

S4009 | vassoio rettangolare | rectang. tray
cm 30x22x1,5 | pz. conf. 1 | c/c 18



€ 15,31

S4010 | vassoio rettangolare | rectang. tray
cm 39x29x1,5 | pz. conf. 1 | c/c 12





€ 5,32

S0118 | set tagliere con ciotola | tray with bowl
cm 35x8,5x2,5 | pz. conf. 1 | c/c 12



€ 6,79

S0119 | set tagliere con ciotola | tray with bowl
cm 50x8,5x2,5 | pz. conf. 1 | c/c 12



€ 3,87

S0061 | vassoio sushi | sushi tray
cm 15x15x2,5 | pz. conf. 1 | c/c 36



€ 4,12

S0061.Z | vassoio sushi | sushi tray
cm 15x15x2,5 | pz. conf. 1 | c/c 36



€ 5,37

S0062 | vassoio sushi | sushi tray
cm 30x11x2,5 | pz. conf. 1 | c/c 36



€ 5,62

S0062.Z | vassoio sushi | sushi tray
cm 30x11x2,5 | pz. conf. 1 | c/c 36



€ 17,73

S0090 | vassoio sushi | sushi tray
cm 70x20x2,5 | pz. conf. 1 | c/c 12



€ 18,11

S0090.Z | vassoio sushi | sushi tray
cm 70x20x2,5 | pz. conf. 1 | c/c 12



€ 12,85

S0063 | vassoio sushi | sushi tray
cm 50x23x2,5 | pz. conf. 1 | c/c 12



€ 13,11

S0063.Z | vassoio sushi | sushi tray
cm 50x23x2,5 | pz. conf. 1 | c/c 12







€ 3,82

S4001 | contenitore da buffet | buffet box
cm 7,7x7,7x5 | pz. conf. 1 | c/c 36



€ 9,23

S0104 | formaggera | cheese bowl
cm Ø 11x5 | pz. conf. 1 | c/c 16



€ 4,88

S4002 | contenitore da buffet | buffet box
cm 7,7x15,3x5 | pz. conf. 1 | c/c 36



€ 5,92

S4003 | contenitore da buffet | buffet box
cm 15,3x15,3x5 | pz. conf. 1 | c/c 24



€ 7,16

S4004 | contenitore da buffet | buffet box
cm 15,3x22,9x5 | pz. conf. 1 | c/c 24



€ 8,28

S4006 | contenitore da buffet | buffet box
cm 15,3x30,6x5 | pz. conf. 1 | c/c 12



€ 6,25

S0078 | portarifiuti in bamboo | bamboo table bin |
cm 11x11x11 | pz. conf. 1 | c/c 24



€ 17,55

S0079 | portabustine | sachet holder
cm 7x11x5,5 | pz. conf. 6 | c/c 6



€ 16,08

S0127 | portaposate Yulin | cutlery holder Yulin |
cm 15x15x15 | pz. conf. 1 | c/c 12



€ 15,54

S0089 | portabustine/posate | sachet/cutlery holder |
cm 29x27,5x6 | pz. conf. 1 | c/c 6



A bamboo buffet table is set on a white tablecloth. The central focus is a large bamboo tray with a clear glass lid, containing sliced meats, cheese, and herbs. To the left, a white bowl is filled with fresh fruit like raspberries, blackberries, and orange slices. In the foreground, several bamboo trays hold bread, fried items, and dumplings. A bamboo container on the right holds silverware, and another holds a stack of white napkins. A vase with pink flowers is in the background.

BAMBOO BUFFET



per tovaglioli
for napkins
cm 25x25

€ 8,23

S0085 | portatovaglioli | napkin holder
cm 13,5x13,5x10 | pz. conf. 1 | c/c 18



per tovaglioli
for napkins
cm 25x25

€ 8,23

S0085.Z | portatovaglioli | napkin holder
cm 13,5x13,5x10 | pz. conf. 1 | c/c 18



per tovaglioli
for napkins
cm 33x33

€ 12,13

S0086 | portatovaglioli | napkin holder
cm 19x19x10 | pz. conf. 1 | c/c 18



per tovaglioli
for napkins
cm 33x33

€ 12,13

S0086.Z | portatovaglioli | napkin holder
cm 19x19x10 | pz. conf. 1 | c/c 18



€ 24,11

S0105 | portabicchieri | glass holder
cm 21x11x30 | pz. conf. 1 | c/c 6



€ 24,11

S0105.Z | portabicchieri | glass holder
cm 21x11x30 | pz. conf. 1 | c/c 6





€ 13,11

S0060.S | ciotola rotonda | round bowl
cm Ø 8x4,2 | pz. conf. 4 | c/c 12



€ 5,87

S0060 | ciotola rotonda | round bowl
cm Ø 11x4,5 | pz. conf. 1 | c/c 36



€ 14,15

S0060.L | ciotola rotonda | round bowl
cm Ø 17x6 | pz. conf. 1 | c/c 12



€ 20,60

S0060.XL | ciotola rotonda | round bowl
cm Ø 20x7,5 | pz. conf. 1 | c/c 12



€ 6,90

S0108 | cassetina | small box
cm 15x10x7 | pz. conf. 1 | c/c 36



€ 9,87

S0096 | cassetina portapane | breadbox
cm 20x15x9 | pz. conf. 1 | c/c 12



€ 16,77

S0095 | cassetina portapane | breadbox
cm 30x20x11 | pz. conf. 1 | c/c 8





€ 3,42

T3033 | vasetto con cucchiaino | glass with spoon
ml 310 | cm Ø 8x8,7 | pz. conf. 1 | c/c 24



€ 19,58

T3032 | set 3 vasetti | 3 bowls set
cm 28x9,3x10 | pz. conf. 1 | c/c 6



€ 13,63

T3030 | barattolo con coperchio | jar with lid
lt 2,25 | cm Ø 15x16 | pz. conf. 1 | c/c 6



€ 14,76

T3031 | barattolo con coperchio | jar with lid
lt 3 | cm Ø 15x20 | pz. conf. 1 | c/c 6



€ 15,98

T3028 | caraffa con tappo | jug with lid
lt 1,7 | pz. conf. 1 | c/c 6



€ 11,75

T3027 | caraffa con tappo | jug with lid
lt 1,5 | pz. conf. 1 | c/c 6





€ 58,56

S0128 | set espositori 3 pz. | 3 pcs bamboo display
cm 13/18/23 | pz. conf. 1 set | c/c 2



€ 93,00

S0130 | set espositori 3 pz. | 3 pcs bamboo display
cm 60/45/30x20 | pz. conf. 1 set | c/c 2



SPECIAL PRICE

€ 74,00

S0128.Z | set espositori 3 pz. | 3 pcs bamboo display
cm 13/18/23 | pz. conf. 1 set | c/c 2



€ 97,76

S0097 | set espositori 3 pz. | 3 pcs bamboo display
cm 60/45/30x30 | pz. conf. 1 | c/c 2





€ 22,64

S0135 | alzatina in bamboo | bamboo stand
cm 34x17x33 | pz. conf. 1 | c/c 6



€ 34,40

S4112 | alzatina bianca | white bamboo stand
cm 31,5x34x50 | pz. conf. 1 | c/c 5



€ 17,33

S0134 | stand bamboo | bamboo stand
cm 20x30x18 | pz. conf. 1 | c/c 6



€ 22,28

S0133 | stand bamboo | bamboo stand
cm 24x40x18 | pz. conf. 1 | c/c 6

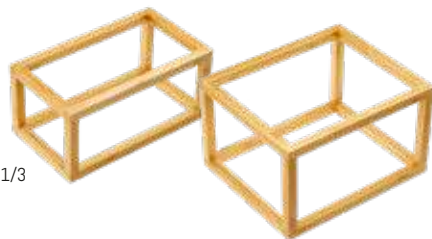

GN 1/2

GN 1/3

€ 28,94

S0136 | set supporti in bamboo | bamboo stand
set GN 1/2 GN 1/3 | pz. conf. 2 | c/c 4







€ 31,90

T5056 | caraffa policarbonato | polycarb. pitcher |
lt. 2 | pz. conf. 1 | c/c 12



€ 10,40

T5052.C | coperchio per ciotola | bowl cover
cm Ø 23 | pz. conf. 1 | c/c 24



€ 5,24

T5002 | mattonella refrigerante | ice box
cm 20x17x3 - 850 ml | pz. conf. 1 | c/c 12



€ 10,40

T5052.P | ciotola in policarbonato | polycarbonate
bowl cm Ø 23 | pz. conf. 1 | c/c 24



€ 1,94

T5024 | mattonella refrigerante | freeze tile |
cm 13,5x12,5x14 | pz. conf. 1 | c/c 50



€ 1,61

T8138 | cucchiaino bianco | white spoon
cm 26,5 | pz. conf. 1 | c/c 48



€ 16,86

S0087 | supporto per caraffa | pitcher stand
cm 20x20x8 | pz. conf. 1 | c/c 6



€ 26,85

S0088 | supporto per ciotole | bowl stand
cm 26x26x11 | pz. conf. 1 | c/c 6



€ 44,80

S51000 | set caraffa | pitcher set
pz. conf. 1 | c/c 1



€ 46,90

S1001 | set ciotola | bowl set
pz. conf. 1 | c/c 1





GN 1/1

€ 50,95

T0550 | coperchio apribile |
openable cover | cm 53x32,5x17,5 |
pz. conf. 1 | c/c 2



€ 5,20

T5106 | jelly bag caldo/freddo |
hot&cold jelly bag | cm 26x16 |
pz. conf. 1 | c/c 24



€ 39,50

T0551 | coperchio apribile |
openable cover | cm 42,5x29x15 |
pz. conf. 1 | c/c 2



GN 1/1

€ 19,40

T8061 | vassoio ambra | ambra tray
cm 53x32,5x2 | pz. conf. 1 | c/c 6



€ 14,16

T8063 | vassoio ambra | ambra tray
cm 41,5x28x2 | pz. conf. 1 | c/c 6



GN 1/1

€ 34,00

T8060 | vassoio ambra | ambra tray
cm 53x32,5x6 | pz. conf. 1 | c/c 6



€ 22,55

T8062 | vassoio ambra | ambra tray
cm 41,5x28x6 | pz. conf. 1 | c/c 6



GN 1/1

€ 43,49

S0100 | base Asia | base Asia
cm 53x32,5x9 | pz. conf. 1 | c/c 2



€ 33,10

S0101 | base Asia | base Asia
cm 42x28x9 | pz. conf. 1 | c/c 4



GN 1/1

€ 111,90

S1003 | set espositore | buffet set
cm 53x32,5x27 | pz. conf. 1 | c/c 1



€ 89,90

S1004 | set espositore | buffet set
cm 42x28x27 | pz. conf. 1 | c/c 1





€ 41,75

S1006 | Set due caraffe + base + mattonelle refrigeranti | Two jugs set + bamboo base + freeze tiles | 1500ml | pz. conf. 1 | c/c 1



€ 59,25

S1007 | Set tre caraffe + base + mattonelle refrigeranti | Three jugs set + bamboo base + freeze tiles | 1500ml | pz. conf. 1 | c/c 1



€ 1,94

T5024 | mattonella refrigerante freeze tile | cm 13,5x12,5x14 | pz. conf. 1 | c/c 50



€ 9,90

T5510 | caraffa in metacrilato | methacrylate jug | cm Ø10x27 ml 1500 | pz. conf. 1 | c/c 12



€ 8,10

T5509 | caraffa in metacrilato | methacrylate jug | cm Ø8x22,5 ml 1000 | pz. conf. 1 | c/c 12



€ 26,82

S0132 | porta bottiglie in bamboo | bamboo bottle holder | cm 42x15,5x13 | pz. conf. 1 | c/c 6



€ 20,25

S0131 | porta bottiglie in bamboo | bamboo bottle holder | cm 29x15,5x13 | pz. conf. 1 | c/c 6







€ 50,95

T0550 | coperchio apribile | openable cover
cm 53x32,5x17,5 | pz. conf. 1 | c/c 2



€ 27,72

T0548.Y | cestino rettangolare | rectang. basket
cm 52,5x32,5x8 | pz. conf. 1 | c/c 18



€ 27,72

T0548 | cestino rettangolare | rectang. basket
cm 52,5x32,5x8 | pz. conf. 1 | c/c 18



€ 39,50

T0551 | coperchio apribile | openable cover
cm 42,5x29x15 | pz. conf. 1 | c/c 2



€ 23,98

T0547.Y | cestino rettangolare | rectang. basket
cm 41,5x28x8 | pz. conf. 1 | c/c 18



€ 23,98

T0547 | cestino rettangolare | rectang. basket
cm 41,5x28x8 | pz. conf. 1 | c/c 18





€ 23,04

T0554 | coperchio per T0549 | cover for T0549
cm 32,5x26x7 | pz. conf. 1 | c/c 24



€ 15,39

T0549.Y | cestino rettangolare | rectang. basket
cm 32,5x26x6 | pz. conf. 1 | c/c 24



€ 15,39

T0549 | cestino rettangolare | rectang. basket
cm 32,5x26x6 | pz. conf. 1 | c/c 24



€ 49,19

T0552 | coperchio rotondo | round cover
cm Ø 43x20 | pz. conf. 1 | c/c 5



€ 17,31

T0537 | cestino rotondo | round basket
cm Ø 40x8 | pz. conf. 1 | c/c 12





€ 18,34

T0544 | cestino rotondo | slanting basket
cm Ø 36x12 | pz. conf. 1 | c/c 12



€ 8,30

T0534.A | cestino da pizza | pizza basket
cm Ø 25x3 | pz. conf. 1 | c/c 24



€ 26,62

T0545 | cestino rotondo | slanting basket
cm Ø 45x18 | pz. conf. 1 | c/c 6



€ 13,02

T0534 | cestino da pizza | pizza basket
cm Ø 35x3 | pz. conf. 1 | c/c 24



€ 13,96

T0527 | cestino quadrato | square basket
cm 30x30x6 | pz. conf. 1 | c/c 24



€ 15,72

T0525 | cestino rettangolare | rectangular basket |
cm 30x40x8 | pz. conf. 1 | c/c 24





€ 22,08

T0528 | cestino inclinato | slanting basket
cm 45x30x5/11 | pz. conf. 1 | c/c 12



€ 23,97

T0540 | cestino inclinato | slanting basket
cm 34x24x11/18 | pz. conf. 1 | c/c 12



€ 74,43

T0536 | cesto inclinato | slanting basket
cm 51x47x13/25 | pz. conf. 1 | c/c 6



€ 61,11

T0546 | set 2 cestini con alzata | set stand
with 2 baskets | cm 30x30x50 | pz. conf. 1 | c/c 3





€ 16,38

T0562 | cestino marrone | brown basket
cm 32,5x17,5x10 | pz. conf. 1 | c/c 30



€ 16,38

T0562.Z | cestino nero | black basket
m 32,5x17,5x10 | pz. conf. 1 | c/c 30



€ 21,60

T0563 | cestino marrone | brown basket
cm 32,5x26,5x10 | pz. conf. 1 | c/c 30



€ 21,60

T0563.Z | cestino nero | black basket
cm 32,5x26,5x10 | pz. conf. 1 | c/c 30



€ 28,19

T0564 | cestino marrone | brown basket
cm 32,5x32,5x10 | pz. conf. 1 | c/c 10



€ 28,19

T0564.Z | cestino nero | black basket
cm 32,5x32,5x10 | pz. conf. 1 | c/c 10



€ 41,44

T0565 | cestino marrone | brown basket
cm 53x32,5x10 | pz. conf. 1 | c/c 10



€ 41,44

T0565.Z | cestino nero | black basket
cm 53x32,5x10 | pz. conf. 1 | c/c 10



VANITY LINE





€ 8,47

T0561.T | cestino tortora | dove grey basket
cm Ø 18x9 | pz. conf. 1 | c/c 24



€ 8,47

T0561.Y | cestino bianco | white basket
cm Ø 18x9 | pz. conf. 1 | c/c 24



€ 8,47

T0561.R | cestino marrone | brown basket
cm Ø 18x9 | pz. conf. 1 | c/c 24



€ 8,47

T0561.Z | cestino nero | black basket
cm Ø 18x9 | pz. conf. 1 | c/c 24



€ 10,59

T0558.Z | cestino nero | black basket
cm 18x18x10 | pz. conf. 1 | c/c 24



€ 9,21

T0559.Z | cestino nero | black basket
cm 16x16x10 | pz. conf. 1 | c/c 24



€ 10,59

T0558.R | cestino marrone | brown basket
cm 18x18x10 | pz. conf. 1 | c/c 24



€ 9,21

T0559.R | cestino marrone | brown basket
cm 16x16x10 | pz. conf. 1 | c/c 24



€ 10,59

T0558.T | cestino tortora | dove grey basket
cm 18x18x10 | pz. conf. 1 | c/c 24



€ 9,21

T0559.T | cestino tortora | dove grey basket
cm 16x16x10 | pz. conf. 1 | c/c 24



BREAD BASKET





€ 6,37

T0004.Z | saccottino nero | black basket
cm 9x9x16 | pz. conf. 1 | c/c 24



€ 7,64

T0005.Z | saccottino nero | black basket
cm 12x12x16 | pz. conf. 1 | c/c 24



€ 6,31

T0003.R | saccottino verde | green basket
cm 14x14x10 | pz. conf. 1 | c/c 24



€ 6,31

T0003.Z | saccottino nero | black basket
cm 14x14x10 | pz. conf. 1 | c/c 24



€ 8,44

T0006.R | saccottino verde | green basket
cm 15x15x16 | pz. conf. 1 | c/c 24



€ 8,44

T0006.Z | saccottino nero | black basket
cm 15x15x16 | pz. conf. 1 | c/c 24



Cestino di Carta lavabile sia a mano che in lavatrice a 40°. Per un perfetto risvoltino: immergere in acqua fredda e lasciare ammorbidire, poi ripiegare il bordo all'altezza desiderata. Lasciare asciugare. Avvertenze: Non ungere, tenere lontano da fonti di calore.

Paper Basket. Hand or machine washable at 40°. Instructions for a perfect turn up: Dip it in cold water. Once softened, fold the edge to the desired height. Allow to dry. Warnings: Do not get grease on, keep away from heat source.





€ 2,48

T0501 | cestino rotondo | round basket
cm Ø 20x6 | pz. conf. 1 | c/c 72



€ 5,16

T0529.Z | cestino naturale Vogue | natural basket
Vogue | cm Ø 20x6,5 | pz. conf. 1 | c/c 36



€ 2,44

T0505 | cestino ovale | oval basket
cm 23x15x6 | pz. conf. 1 | c/c 72



€ 5,16

T0529.Y | cestino nero Vogue | black basket Vogue |
cm Ø 20x6,5 | pz. conf. 1 | c/c 36



€ 7,01

T0533.R | cestino bicolor | bicolor basket
cm 23x19x6,5 | pz. conf. 1 | c/c 36



€ 5,16

T0529.P | cestino cacao Vogue | cocoa basket Vogue |
cm Ø 20x6,5 | pz. conf. 1 | c/c 36



€ 5,28

T0530.R | cestino bicolor | bicolor basket
cm Ø 21x6,5 | pz. conf. 1 | c/c 36



€ 5,16

T0529.A | cestino bianco Vogue | white basket Vogue |
cm Ø 20x6,5 | pz. conf. 1 | c/c 36



€ 5,74

T0532.R | cestino bicolor | bicolor basket
cm 24x16,5x6 | pz. conf. 1 | c/c 36



€ 5,16

T0529.T | cestino tortora Vogue | dove grey basket
Vogue | cm Ø 20x6,5 | pz. conf. 1 | c/c 36



€ 7,58

T0531.R | portagrissini bicolor | bicolor breadstick
basket | cm Ø 12x15 | pz. conf. 1 | c/c 36



T0520.Y

T0520.Z

€ 7,87

cestino Vogue | Vogue basket | cm 28x11x7 |
pz. conf. 1 | c/c 40





€ 206,88

P5001 | scaldavivande tondo | roll top chafing dish |
cm 47x47x45 | pz. conf. 1 | c/c 1



€ 259,92

P5000 | scaldavivande | chafing dish
cm 63,5x45,5x44 | pz. conf. 1 | c/c 1



€ 97,60

P5003 | scaldavivande | chafing dish
cm 58, 5x35x32 | pz. conf. 1 | c/c 1



€ 196,27

P5002 | scaldavivande | chafing dish
cm 61x36x43 | pz. conf. 1 | c/c 1



€ 32,89

P5006 | bacinella tonda | round food pan
cm Ø 39x7 | pz. conf. 1 | c/c 3



€ 30,77

P5004 | bacinella rettang. | rect. food pan
cm 53x32,5x6,5 | pz. conf. 1 | c/c 3



CE



- Voltaggio/ Voltage 220/240V
- Temp. Max 90°
- Potenza/ Power 400W
- Adatta a tutti i modelli/ Suitable for any model

€ 33,42

P5007 | piastra elettrica | electric heating
400 w | pz. conf. 1 | c/c 4



- Acciaio Inox lucido/ *shining stainless steel*
- Modello rettangolare fornito di 2 bruciatori removibili, 1 bruciatore per il modello rotondo / *rectangular shape equipped with 2 removable cans, one can for round shape.*
- Maniglia ergonomica/ *Ergonomic handle*
- Dotato di viti per l'utilizzo anche con piastra elettrica/ *Equipped with screws to be used with electric panel*
- Blocco parziale e totale/ *Partial or total lock (P5000 - P5001)*
- Bacinella gastronorm in acciaio inox 18/10 / *Gastronorm pan 1/1 ss 18/10 (P5004)*

CHAFING DISH





€ 42,33

P5102 | dispenser cereali |
cereal dispenser
lt. 1,8 | pz. conf. 1 | c/c 4



€ 58,25

P5103 | dispenser succhi |
juice dispenser
lt. 3 | pz. conf. 1 | c/c 4





€ 19,90

P5112 | caraffa termica | vacuum jug
lt 1,5 | pz. conf. 1 | c/c 6



€ 29,90

P5114.Z | caraffa termica | vacuum jug
lt 1,2 | pz. conf. 1 | c/c 6



€ 29,90

P5114.Y | caraffa termica | vacuum jug
lt 1,2 | pz. conf. 1 | c/c 6



ACCIAIO INOX



Design semplice, manico ergonomico, tappo isolante con beccuccio, base antiscivolo.

Mantiene le bevande calde o fredde fino a 24 h.
Interno ed esterno in acciaio inossidabile.

Simple design, ergonomic handle, insulating cap with functional spout, non-slip base. Keeps drinks hot or cold up to 24 hours. Stainless steel inside and outside.



€ 3,75

S0201 | bancalino in legno | fir mini pallet
cm 20x12x3,5 | pz. conf. 1 | c/c 24



SPECIAL PRICE

€ 2,63

S0201.P | bancalino bianco | white mini pallet
cm 20x12x3,5 | pz. conf. 1 | c/c 24



€ 7,43

S0202 | bancalino in legno | fir mini pallet
cm 35x20x3,5 | pz. conf. 1 | c/c 16



SPECIAL PRICE

€ 6,69

S0202.P | bancalino bianco | white mini pallet
cm 35x20x3,5 | pz. conf. 1 | c/c 16



€ 7,23

S0203 | bancalino in legno | fir mini pallet
cm 40x15x3,5 | pz. conf. 1 | c/c 16



SPECIAL PRICE

€ 6,51

S0203.P | bancalino bianco | white mini pallet
cm 40x15x3,5 | pz. conf. 1 | c/c 16



€ 8,99

S0205 | cassetta in legno | fir wood basket
cm 25x17x10 | pz. conf. 1 | c/c 12



€ 8,99

S0205.P | cassetta bianca | white wooden basket |
cm 25x17x10 | pz. conf. 1 | c/c 12



€ 4,84

S0204 | cassetta in legno | fir wood basket
cm 17x12x9 | pz. conf. 1 | c/c 24



€ 4,84

S0204.P | cassetta bianca | white wooden
cm 17x12x9 | pz. conf. 1 | c/c 24



€ 2,20

S0206 | cassetta in legno | fir wood basket
cm 13,5x8,5x6,7 | pz. conf. 1 | c/c 32



€ 5,98

S0210.P | cassetta bianca | white wooden basket |
cm 27x15x6 | pz. conf. 1 | c/c 24



BETULLA





€ 8,38

T5422 | cestello quadrato | square basket
cm 10x10x8 | pz. conf. 1 | c/c 12



€ 9,45

T5423 | cestello tondo | round basket
cm Ø 9x10,5 | pz. conf. 1 | c/c 12



€ 13,69

T5424 | cestello rettangolare | rectangular basket |
cm 21x10x6 | pz. conf. 1 | c/c 12



€ 10,08

T5420 | cestello quadrato | square basket
cm 12,7x12,7x10 | pz. conf. 1 | c/c 12



€ 4,14

T5426 | portacono | cones basket
cm Ø 7x14,5 | pz. conf. 1 | c/c 12



€ 7,92

T5431.M | scolapasta rosso | red colander
cm Ø 18 | pz. conf. 1 | c/c 24



€ 7,92

T5431.0 | scolapasta avorio | ivory colander
cm Ø 18 | pz. conf. 1 | c/c 24



€ 7,92

T5431.T | scolapasta tortora | dove grey colander |
cm Ø 18 | pz. conf. 1 | c/c 24



FRITTO MANIA





€ 8,90

P1007 | tumbler in acciaio | stainless steel tumbler |
cm Ø8x11 | 340ml | pz. conf. 1 | c/c 24



€ 1,50

P1007.T | tappo per P1007 | lid for P1007
cm Ø8 | pz. conf. 1 | c/c 12



€ 12,09

P1004 | moscow mule | moscow mule
ml. 590 | pz. conf. 1 | c/c 24



€ 7,75

P1008 | set 3 ciotole in acciaio | stainless steel
bowls set | cm Ø 9 / 11 / 13 | pz. conf. 3 | c/c 24



€ 8,25

P1010 | tazza moscow mule | moscow mule mug |
cm Ø8,5x10 | 420ml | pz. conf. 1 | c/c 24



€ 8,00

P1009 | set 3 ciotole in acciaio | stainless steel
bowls set | cm Ø 9 / 11 / 13 | pz. conf. 3 | c/c 24





€ 9,63

P2002 | casseruola | casserole | cm Ø8,25x5 |
pz. conf. 1 | c/c 12



€ 12,11

P2004 | padellino | mini pan
cm Ø 12x4 | pz. conf. 1 | c/c 12



€ 12,98

P2003 | casseruola | casserole
cm Ø 12x6 | pz. conf. 1 | c/c 12



€ 11,25

P2000 | tegamino | mini pan
cm Ø 10x4,25 | pz. conf. 1 | c/c 12



€ 15,14

P2001 | tegamino | mini pan
cm Ø 13x4,25 | pz. conf. 1 | c/c 12





€ 15,43

P2109 | vassoio in acciaio | stainless steel tray
cm 20x11,5x1,3 | pz. conf. 1 | c/c 8



€ 17,47

P2110 | vassoio color rame | copper-color tray |
cm 25,5x11,5x1,3 | pz. conf. 1 | c/c 8



€ 20,08

P2111 | vassoio in acciaio | stainless steel tray
cm 25,5x11,5x1,3 | pz. conf. 1 | c/c 8



€ 23,70

P2112 | vassoio color rame | copper-color tray |
cm 30,5x21x1,3 | pz. conf. 1 | c/c 6



€ 24,52

P2113 | vassoio in acciaio | stainless steel tray
cm 30,5x21x1,3 | pz. conf. 1 | c/c 6



€ 31,53

P2114 | vassoio in acciaio | stainless steel tray
cm 50x11,5x1,3 | pz. conf. 1 | c/c 6



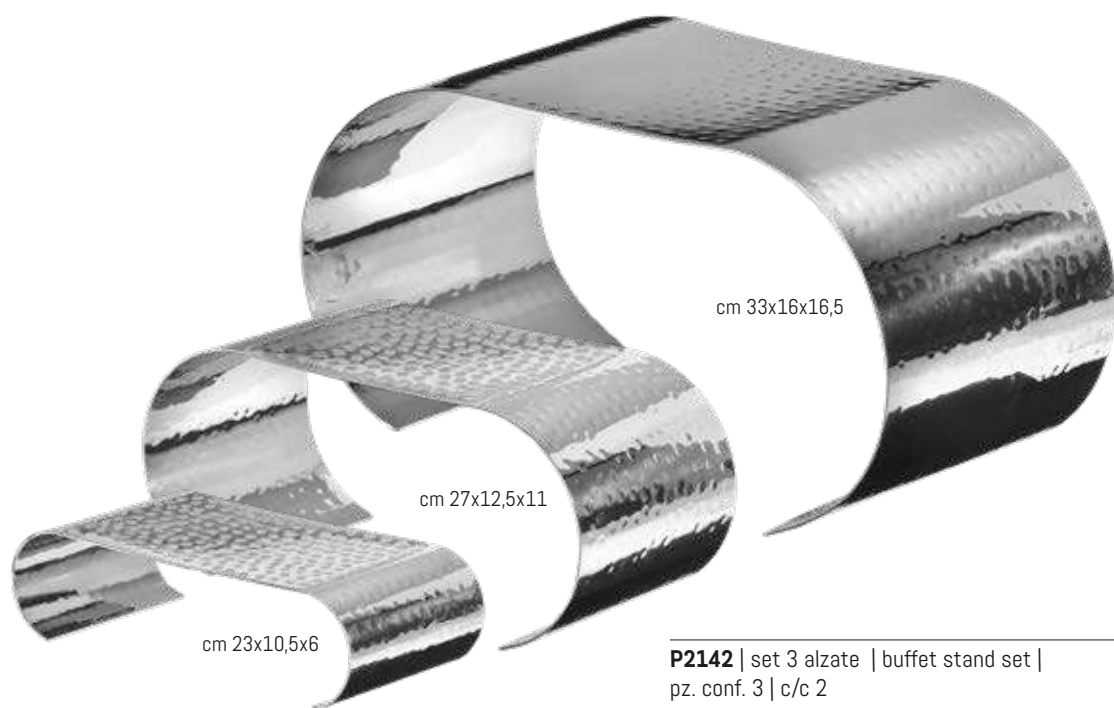

cm 23x10,5x6

cm 27x12,5x11

cm 33x16x16,5

€ 122,09

P2142 | set 3 alzate | buffet stand set |
pz. conf. 3 | c/c 2





SPECIAL PRICE

€ 7,15

P2133 | ciotolina color rame | copper-color bowl |
cm Ø8x5 | pz. conf. 1 | c/c 24



SPECIAL PRICE

€ 6,60

P2132 | ciotolina color rame | copper-color bowl |
cm 10x10x5 | pz. conf. 1 | c/c 24



SPECIAL PRICE

€ 8,09

P2134 | ciotolina color rame | copper-color bowl |
cm Ø7x5 | pz. conf. 1 | c/c 24



SPECIAL PRICE

€ 9,92

P2136 | secchiello color rame | copper-color basket |
cm Ø10,8x8 | pz. conf. 1 | c/c 24



SPECIAL PRICE

€ 11,06

P2135 | ciotolina color rame | copper-color bowl |
cm Ø7x9 | pz. conf. 1 | c/c 24



SPECIAL PRICE

€ 9,57

P2137 | secchiello color rame | copper-color basket |
cm Ø11,2x10 | pz. conf. 1 | c/c 24



SPECIAL PRICE

€ 7,33

P2131 | ciotolina color rame | copper-color bowl |
cm Ø8x6 | pz. conf. 1 | c/c 24



SPECIAL PRICE

€ 11,06

P2138 | secchiello color rame | copper-color basket |
cm Ø12x12 | pz. conf. 1 | c/c 24



COPPER STYLE







SPECIAL PRICE

€ 6,44

P2128 | ciotolina in acciaio | stainless steel bowl |
cm Ø8x5 | pz. conf. 1 | c/c 24



SPECIAL PRICE

€ 5,94

P2129 | ciotolina in acciaio | stainless steel bowl |
cm 10x10x5 | pz. conf. 1 | c/c 24



SPECIAL PRICE

€ 7,10

P2125 | secchiello in acciaio | stainless steel basket |
cm Ø10,8x8 | pz. conf. 1 | c/c 24



SPECIAL PRICE

€ 6,44

P2123 | coppetta cilindrica | cylindrical cup
cm Ø7x5 | pz. conf. 1 | c/c 24



SPECIAL PRICE

€ 8,91

P2126 | secchiello in acciaio | stainless steel basket |
cm Ø11,2x10 | pz. conf. 1 | c/c 24



SPECIAL PRICE

€ 10,40

P2124 | coppetta cilindrica | cylindrical cup
cm Ø7x9 | pz. conf. 1 | c/c 24



SPECIAL PRICE

€ 10,40

P2127 | secchiello in acciaio | stainless steel basket |
cm Ø12x12 | pz. conf. 1 | c/c 24



SPECIAL PRICE

€ 6,52

P2130 | ciotolina in acciaio | stainless steel bowl |
cm Ø8x6 | pz. conf. 1 | c/c 24





€ 10,94

P2120 | ciotola in acciaio | stainless steel bowl |
cm Ø 15x8 | pz. conf. 1 | c/c 12



€ 11,18

P2119 | ciotola color rame | copper-color bowl |
cm Ø 15x8 | pz. conf. 1 | c/c 12



€ 13,55

P2105 | ciotola in acciaio | stainless steel bowl |
cm Ø 20x10 | pz. conf. 1 | c/c 12



€ 14,42

P2104 | ciotola color rame | copper-color bowl |
cm Ø 20x10 | pz. conf. 1 | c/c 1



€ 28,32

P2122 | griglia per P2101 | ice grid for P2101
cm Ø 38,5 | pz. conf. 1 | c/c 3



€ 21,45

P2121 | griglia per P2100 | ice grid for P2100
cm Ø 28 | pz. conf. 1 | c/c 3



€ 40,85

P2101 | vassoio tondo | round tray
cm Ø 40 | pz. conf. 1 | c/c 6



€ 31,53

P2100 | vassoio tondo | round tray
cm Ø 30 | pz. conf. 1 | c/c 6







SPECIAL PRICE

€ 14,80

P2143 | ciotola quadrata | square bowl |
cm 13x13x7 | pz. conf. 1 | c/c 4



€ 20,79

P2139 | ciotola in acciaio | stainless steel bowl |
cm Ø15x9,5 | pz. conf. 1 | c/c 6



SPECIAL PRICE

€ 24,08

P2144 | ciotola quadrata | square bowl |
cm 18x18x8,5 | pz. conf. 1 | c/c 4



€ 35,51

P2140 | ciotola in acciaio | stainless steel bowl |
cm Ø 20x12 | pz. conf. 1 | c/c 6



SPECIAL PRICE

€ 35,45

P2145 | ciotola quadrata | square bowl |
cm 24x24x10 | pz. conf. 1 | c/c 4



€ 52,79

P2141 | ciotola in acciaio | stainless steel bowl |
cm Ø 25,5x12,5 | pz. conf. 1 | c/c 4





€ 25,36

P2103 | glacette | wine cooler
cm Ø 12x18,5 | pz. conf. 1 | c/c 8



€ 19,97

T5092 | glacette acciaio | stainless steel cooler |
cm Ø 12x19,5 | pz. conf. 1 | c/c 24



SPECIAL PRICE

€ 31,58

P2107 | secchiello ghiaccio | ice bucket
cm Ø 27x14 | pz. conf. 1 | c/c 4



€ 33,94

P2102 | secchiello ghiaccio | wine bucket
cm Ø 23x21,5 | pz. conf. 1 | c/c 6



SPECIAL PRICE

€ 55,21

P2108 | secchiello ghiaccio | ice bucket
cm Ø 43x17,5 | pz. conf. 1 | c/c 2



SPECIAL PRICE

€ 58,56

P2106 | secchiello ghiaccio | ice bucket
cm Ø 37,5x17 | pz. conf. 1 | c/c 2





€ 5,46

T5091 | portaggiaccio | ice bucket
cm Ø 14x13 | pz. conf. 1 | c/c 24



€ 12,18

T5012.T | secchiello acrilico | acrylic ice bucket |
lt. 3,5 | pz. conf. 1 | c/c 20



€ 13,88

P1005 | secchiello portaggiaccio | ice bucket
cm 22x20 | pz. conf. 1 | c/c 12



€ 8,14

T5011 | copribottiglie refriger. | bottle cooler
cm 18,5 | pz. conf. 1 | c/c 24



€ 13,88

P1006 | secchiello portaggiaccio | ice bucket
cm 22x20 | pz. conf. 1 | c/c 12



€ 18,98

T5506 | portaggiaccio | ice bucket
cm 20/23,6x20 | pz. conf. 1 | c/c 12



€ 59,36

P1011 | colonna porta secchiello | wine bucket holder |
cm Ø19x72 | pz. conf. 1 | c/c 3



€ 59,56

T5090 | secchiello champagne | champagne bowl |
cm Ø 39x25 | pz. conf. 2





€ 3,40

T5084 | mini secchiello in latta | small tin bucket |
cm Ø 12x10,8 | pz. conf. 1 | c/c 24



€ 2,08

P3000 | secchiello in latta | tin bucket
cm 12,2x7 | pz. conf. 1 | c/c 36



€ 4,19

T5085 | mini secchiello in latta | small tin bucket |
cm Ø 13x12 | pz. conf. 1 | c/c 24



€ 6,31

T5083 | vaschetta in latta | tin basin
cm 23x15x8 | pz. conf. 1 | c/c 6



€ 21,10

T5081 | secchiello ghiaccio | ice tin basin
lt. 16 | pz. conf. 1 | c/c 6



€ 10,35

T5080 | secchiello ghiaccio | ice tin basin
lt. 5 | pz. conf. 1 | c/c 12





€ 17,55

T5508 | caraffa in metacrilato |
methacrylate pitcher | lt. 1,7 |
pz. conf. 1 | c/c 12



€ 23,32

T5507 | caraffa in metacrilato |
methacrylate pitcher | lt. 1,6 |
pz. conf. 1 | c/c 12



€ 17,45

T5501 | caraffa trasparente |
transparent pitcher | lt. 1,7 |
pz. conf. 1 | c/c 12



€ 31,16

T5502 | caraffa in metacrilato |
methacrylate pitcher | lt. 1,8 |
pz. conf. 1 | c/c 6



€ 31,90

T5056 | caraffa in policarbonato |
polycarbonate pitcher | lt. 2 |
pz. conf. 1 | c/c 12



€ 6,02

T5064 | caraffa trasparente |
transparent pitcher | lt. 0,95 |
pz. conf. 1 | c/c 12



€ 9,18

T5065 | caraffa trasparente |
transparent pitcher | lt. 1,7 |
pz. conf. 1 | c/c 12



€ 9,90

T5510 | caraffa in metacrilato |
methacrylate jug | cm Ø10x27
lt. 1,5 | pz. conf. 1 | c/c 12



€ 8,10

T5509 | caraffa in metacrilato |
methacrylate jug | cm Ø8x22,5
lt. 1 | pz. conf. 1 | c/c 12



CARAFFE





€ 23,60

G5023 | bicchiere Elegance |
glass Elegance | ml 360 |
pz. conf. 6 | c/c 3



€ 37,92

G5002 | flute Perlage |
flute Perlage | ml 240 |
pz. conf. 6 | c/c 3



€ 30,38

G5021 | flute Petit Perlage |
flute Petit Perlage | ml 160 |
pz. conf. 6 | c/c 32



€ 37,92

G5000 | calice Wine Cocktail |
glass Wine Cocktail | ml 470 |
pz. conf. 6 | c/c 3



€ 37,92

G5001 | calice Redone |
glass Redone | ml 510 |
pz. conf. 6 | c/c 3



€ 33,44

G5033 | bicchiere Ballon mix |
mix glass Ballon | ml 580 |
pz. conf. 6 | c/c 3



€ 6,98

G2763PP | bicchiere
Granity | glass Granity |
ml 400 | pz. conf. 5 | c/c 15



€ 8,68

G2764PP | bicchiere Rox |
glass Rox | ml 290 |
pz. conf. 8 | c/c 15



€ 8,99

G2763 | bicchiere Granity |
glass Granity | ml 400 |
pz. conf. 5 | c/c 15



€ 11,90

G2764 | bicchiere Rox |
glass Rox | ml 290 |
pz. conf. 8 | c/c 15

INFRANGIBILI





€ 19,90

T5610.V | shaker rame |
copper shaker | ml 700 |
pz. conf. 1 | c/c 8



€ 14,90

T5610.S | shaker acciaio |
steel shaker | ml 700 |
pz. conf. 1 | c/c 8



€ 19,90

T5610.Z | shaker nero |
black shaker | ml 700 |
pz. conf. 1 | c/c 8



€ 26,90

T5609.V | boston shaker rame |
copper boston shaker |
ml 530/820 | pz. conf. 1 | c/c 6



€ 19,90

T5609.S | boston shaker acciaio |
steel boston shaker |
ml 530/820 | pz. conf. 1 | c/c 6



€ 26,90

T5609.Z | boston shaker nero |
black boston shaker |
ml 530/820 | pz. conf. 1 | c/c 6



€ 11,90

T5613.V | colino rame |
copper bar strainer | cm 16x9,8
pz. conf. 1 | c/c 12



€ 9,45

T5613.S | colino acciaio |
steel bar strainer | cm 16x9,8
pz. conf. 1 | c/c 12



€ 11,90

T5613.Z | colino nero |
black bar strainer | cm 16x9,8
pz. conf. 1 | c/c 12



PREMIUM





€ 10,50

T5611.V | misurino rame |
copper jigger | ml 25/50 |
pz. conf. 1 | c/c 12



€ 7,90

T5611.S | misurino acciaio |
steel jigger | ml 25/50 |
pz. conf. 1 | c/c 12



€ 10,50

T5611.Z | misurino nero |
black jigger | ml 25/50 |
pz. conf. 1 | c/c 12



€ 8,53

T5614.V | pinza rame |
copper tong | cm 16,7x2,7 |
pz. conf. 1 | c/c 12



€ 6,93

T5614.S | pinza acciaio |
steel tong | cm 16,7x2,7 |
pz. conf. 1 | c/c 12



€ 8,53

T5614.Z | pinza nera |
black tong | cm 16,7x2,7 |
pz. conf. 1 | c/c 12



€ 9,90

T5615.V | pestello rame |
copper pestle | cm Ø 34x20,8 |
pz. conf. 1 | c/c 12



€ 7,90

T5615.S | pestello acciaio |
steel pestle | cm Ø 34x20,8 |
pz. conf. 1 | c/c 12



€ 9,90

T5615.V | pestello nero |
black pestle | cm Ø 34x20,8 |
pz. conf. 1 | c/c 12



€ 9,50

T5612.V | miscelatore rame |
copper bar spoon | cm 33 |
pz. conf. 1 | c/c 12



€ 7,50

T5612.S | miscelatore acciaio |
steel bar spoon | cm 33 |
pz. conf. 1 | c/c 12



€ 9,50

T5612.Z | miscelatore nero |
black bar spoon | cm 33 |
pz. conf. 1 | c/c 12







€ 2,87

T5071 | apribottiglia | corkscrew
pz. conf. 1 | c/c 12



€ 3,54

T5608 | tappo da champagne | champagne stopper |
pz. conf. 1 | c/c 20



€ 11,79

T5051 | beccuccio versa liquidi | chrome pourer |
pz. conf. 6 | c/c 10



€ 4,02

T5004 | paletta piccola | small scoop
cm 26x9x4 | pz. conf. 1 | c/c 72



€ 16,87

T5604 | spremi lime | lime squeezer
pz. conf. 1 | c/c 12



€ 2,97

T5607 | bicchiere da shaker | glass for shaker
ml. 480 | pz. conf. 1 | c/c 16



SPECIAL PRICE

€ 3,53

T5088 | cucchiaino colino | strainer spoon
cm 23 | pz. conf. 1 | c/c 96



€ 5,09

T5094 | misurino cocktail | jigger
ml. 20/40 | pz. conf. 1 | c/c 24



€ 8,27

T5603 | pinza da chef | giant tweezer
cm 30 | pz. conf. 1 | c/c 10



€ 5,19

T5060 | pestello in abs | abs pestle
cm 20 | pz. conf. 1 | c/c 12



BARMAN STYLE





€ 21,09

T5059 | portacondimenti | condiment holder
cm 14x30x9 | pz. conf. 1 | c/c 12



€ 14,29

T5044 | bordatore per bicchieri | glass rimmer
cm Ø 15,5 | pz. conf. 1 | c/c 24



€ 30,15

T5057 | portacondimenti | condiment holder
cm 38x15x10 | pz. conf. 1 | c/c 16



€ 40,80

T5042 | portacondimenti | condiment holder
cm 50x15,5x9 - 600 ml | pz. conf. 1 | c/c 12



€ 30,15

T5058 | portacondimenti | condiment holder
cm 46x15x10 | pz. conf. 1 | c/c 16



€ 40,80

T5043 | portacondimenti | condiment holder
cm 50x15,5x9 - 400 ml | pz. conf. 1 | c/c 12



€ 8,18

T5040 | bar organizer | bar organizer
cm 15x22x10 | pz. conf. 1 | c/c 12



bottiglie
non include

bottles
not included

€ 30,50

T5077 | dispenser portabottiglie | dispenser for bottle
cm 55x10x16 | pz. conf. 1 | c/c 6





€ 6,31

T5021 | vassoio antiscivolo | antislip rubber tray |
cm Ø 36 | pz. conf. 1 | c/c 12



€ 8,69

T5023 | vassoio antiscivolo | antislip rubber tray |
cm Ø 40 | pz. conf. 1 | c/c 12



€ 6,31

T5020 | vassoio antiscivolo | antislip rubber tray |
cm 25x35 | pz. conf. 1 | c/c 12



€ 8,87

T5022 | vassoio antiscivolo | antislip rubber tray |
cm 35x45 | pz. conf. 1 | c/c 12



€ 16,93

T5046 | tappetino gomma | rubber mat
cm 30x40 | pz. conf. 1 | c/c 20



€ 13,49

T5045 | tappetino gomma | rubber mat
cm 60x8 | pz. conf. 1 | c/c 50



€ 15,81

T5066 | flair bottle | flair bottle
cm 28 | pz. conf. 1 | c/c 24



€ 6,93

T5048 | pour master completo | pour & store
lt. 1 | pz. conf. 1 | c/c 12





€ 1,90

T5063 | molla per ghiaccio | ice tong
cm 20 | pz. conf. 1 | c/c 12



€ 5,00

T5075 | pinza in acciaio | stainless steel tong
cm 22 | pz. conf. 1 | c/c 24



€ 3,40

T5074 | pinza in acciaio | stainless steel tong
cm 18 | pz. conf. 1 | c/c 40



€ 5,02

P4007 | set coppapasta tondi | round food ring |
cm Ø 6- 8- 10,5x4,5 | pz. conf. 3 | c/c 24



€ 5,02

P4008 | set coppapasta quadrati | square food ring |
cm 6- 8- 10x4,5 | pz. conf. 3 | c/c 24



€ 3,96

T5401 | portauovo | egg cup
cm 10x3 | pz. conf. 1 | c/c 96





- T5013.I** | squeeze bottle gialla | yellow squeeze bottle
ml. 230 | pz. conf. 6 | c/c 12 € 8,25
- T5013.M** | squeeze bottle rossa | red squeeze bottle
ml. 230 | pz. conf. 6 | c/c 12 € 8,25
- T5013.T** | squeeze bottle trasp. | trans. squeeze bottle
ml. 230 | pz. conf. 6 | c/c 12 € 8,25
- T5015.I2** | squeeze bottle gialla | yellow squeeze bottle
ml. 340 | pz. conf. 6 | c/c 6 € 10,70
- T5015.M2** | squeeze bottle rossa | red squeeze bottle
ml. 340 | pz. conf. 6 | c/c 6 € 10,70
- T5015.T2** | squeeze bottle trasp. | trans. squeeze bottle
ml. 340 | pz. conf. 6 | c/c 6 € 10,70
- T5005** | squeeze bottle trasp. | trans. squeeze bottle
ml. 500 | pz. conf. 1 | c/c 36 € 2,28
- T5014.I** | squeeze bottle gialla | yellow squeeze bottle
ml. 680 | pz. conf. 6 | c/c 4 € 16,00
- T5014.M** | squeeze bottle rossa | red squeeze bottle
ml. 680 | pz. conf. 6 | c/c 4 € 16,00
- T5014.T** | squeeze bottle trasp. | trans. squeeze bottle
ml. 680 | pz. conf. 6 | c/c 4 € 16,00
- T5006** | squeeze bottle trasp. | trans. squeeze bottle
ml. 950 | pz. conf. 1 | c/c 24 € 3,21



€ 16,01

- T0509** | cestino americano | american basket
cm 27,5x17,5x3,8 | pz. conf. 12 | c/c 12



€ 13,14

- T0508** | cestino americano | american basket
cm 23,5x15x4,6 | pz. conf. 12 | c/c 12





€ 0,77

T5286 | vaschetta trasparente | transparent tray
cm 12,5x8,5x4,5 | pz. conf. 1 | c/c 36



€ 1,17

T5287 | vaschetta trasparente | transparent tray
cm 26,5x8,7x4,5 | pz. conf. 1 | c/c 36



€ 1,17

T5285.T | mini secchiello grigio | grey mini bucket
ml 450 | pz. conf. 1 | c/c 36



€ 1,17

T5285.A | mini secchiello bianco | white mini bucket
ml 450 | pz. conf. 1 | c/c 36



€ 1,58

T5284.A | secchiello bianco | white bucket
ml 1200 | pz. conf. 1 | c/c 36



€ 1,58

T5284.T | secchiello grigio | grey bucket
ml 1200 | pz. conf. 1 | c/c 36



€ 3,40

T5026 | secchiello tortora | dove grey bucket
cm Ø 13x17 - 1 l | pz. conf. 1 | c/c 24



€ 3,40

T5027 | secchiello bianco | white bucket
cm Ø 13x17 - 1 l | pz. conf. 1 | c/c 24



€ 14,23

T5409 | portarifiuti da tavola | table bin
cm 12x16 | pz. conf. 1 | c/c 24



€ 6,25

S0078 | portarifiuti in bamboo | bamboo table bin |
cm 11x11x11 | pz. conf. 1 | c/c 24





€ 14,80

T5000.Y2 | vaschetta portabustine | sachet holder | PS
cm 8x5x5 | pz. conf. 12 | c/c 12



€ 14,80

T5000.2 | vaschetta portabustine | sachet holder | PS
cm 8x5x5 | pz. conf. 12 | c/c 12



€ 14,80

T5000.Z2 | vaschetta portabustine | sachet holder | PS
cm 8x5x5 | pz. conf. 12 | c/c 12



€ 2,79

T8218 | portabustine melamina | melamine sachet holder | MF
cm 9x6x5 | pz. conf. 1 | c/c 48



€ 17,55

S0079 | portabustine | sachet holder | W
m 7x11x5,5 | pz. conf. 6 | c/c 6



€ 6,26

T1007 | portatovaglioli silver | silver napkin holder | Fe
cm 10x9x13 | pz. conf. 1 | c/c 24



€ 6,26

T1008 | portatovaglioli journal | journal napkin holder | Fe
cm 10x9x13 | pz. conf. 1 | c/c 24



€ 6,26

T1009 | portatovaglioli vintage | vintage napkin holder | Fe
cm 10x9x13 | pz. conf. 1 | c/c 24



€ 7,53

T1005.K | portatovaglioli argento | silver napkin holder | SS
cm 10x9x13 | pz. conf. 1 | c/c 24



€ 7,53

T1005.Z | portatovaglioli nero | black napkin holder | SS
cm 10x9x13 | pz. conf. 1 | c/c 24



€ 10,63

T5096.Z | grembiule nero |
black twill apron cm 72x84 |
pz. conf. 1 | c/c 36



€ 8,55

T5095.Z | parananza nera |
black twill apron cm 59x30 |
pz. conf. 1 | c/c 24



€ 3,58

T5017 | tagliere piccolo | small chopping
cm 16x22x1 | pz. conf. 1 | c/c 40



€ 7,32

T5018 | tagliere medio | medium chopping
cm 22x29x1 | pz. conf. 1 | c/c 30



€ 10,50

T5019 | tagliere grande | big chopping
cm 29x44x1 | pz. conf. 1 | c/c 18





€ 4,42

T5098 easy 100 | guanto forno | oven mitt
cm 38 | pz. conf. 1 | c/c 12



€ 6,78

T5099 easy 100 | guanto forno | oven mitt
cm 61 | pz. conf. 1 | c/c 12



€ 9,79

T5103 proof 320 | guanto forno | oven mitt
cm 38 | pz. conf. 1 | c/c 12



€ 16,38

T5104 proof 320 | guanto forno | oven mitt
cm 61 | pz. conf. 1 | c/c 12



€ 6,59

T5101 proof 220 | guanto forno | oven mitt
cm 38 | pz. conf. 1 | c/c 12



€ 9,53

T5102 proof 220 | guanto forno | oven mitt
cm 61 | pz. conf. 1 | c/c 126



€ 3,87

T5121 proof 220 | presina da forno | pot holder
cm 20x20 | pz. conf. 1 | c/c 24



€ 5,97

T5041.Z | rotolo antiscivolo | antislip mat
cm 30x110 | pz. conf. 1 | c/c 25





€ 13,28

T4220 | macina S/P | S/P transparent mill cm 20 | pz. conf. 1 | c/c 24



€ 16,88

T4216 | macina S/P nero | S/P black mill cm 20 | pz. conf. 1 | c/c 24



€ 16,88

T4217 | macina S/P bianco | S/P white mill cm 20 | pz. conf. 1 | c/c 24



€ 11,48

T4218 | macina S/P bianco | S/P white mill cm 20 | pz. conf. 1 | c/c 24



€ 11,48

T4219 | macina S/P nero | S/P black mill cm 20 | pz. conf. 1 | c/c 24



SALE&PEPE





€ 13,27

T4203 | macina legno | wood mill | cm 20 | pz. conf. 1 | c/c 24



€ 11,45

T4215 | macina legno | wood mill | cm 15 | pz. conf. 1 | c/c 24



€ 12,97

T4202 | macina trasparente | transparent mill | cm 30 | pz. conf. 1 | c/c 24



€ 8,49

T4201 | macina trasparente | transparent mill | cm 20 | pz. conf. 1 | c/c 24



€ 5,20

T4200 | macina trasparente | transparent mill | cm 10 | pz. conf. 1 | c/c 48



SALT&PEPPER



€ 8,34

T3203 | bicchierino Fiji | small glass Fiji
cm Ø 5,7x5,7x4 - 70 ml | pz. conf. 6 | c/c 10



€ 10,08

T3200 | bicchierino Hilo | small glass Hilo
cm Ø 6,8x4,7 - 110 ml | pz. conf. 6 | c/c 10



€ 10,55

T3201 | bicchierino Maui | small glass Maui
cm Ø 5,3x5 - 110 ml | pz. conf. 6 | c/c 10



€ 10,99

T3202 | bicchierino Tonga | small glass Tonga
cm Ø 7,8x5,7 - 42 ml | pz. conf. 6 | c/c 10



€ 10,87

T3204 | bicchierino Samoa | small glass Samoa |
cm Ø 7,5x5 - 100 ml | pz. conf. 6 | c/c 10



€ 9,67

T3205 | bicchierino Tahiti | small glass Tahiti
cm Ø 4,7x6,8 - 70 ml | pz. conf. 6 | c/c 10



€ 5,76

T3206 | ciotola vetro | glass bowl
ml 280 | cm 10x10x5 | pz. conf. 4 | c/c 12



€ 5,40

T3209 | ciotola vetro | glass bowl
ml 200 | cm Ø 8,5x5 | pz. conf. 4 | c/c 12



€ 5,76

T3208 | ciotola vetro | glass bowl
ml 280 | cm 10x10x5 | pz. conf. 4 | c/c 12



€ 5,76

T3207 | ciotola vetro | glass bowl
ml 280 | cm 10x10x5 | pz. conf. 4 | c/c 12







3 lt

€ 29,17

T3023 | big jar c/supporto |
big jar with tin base |
pz. conf. 1 | c/c 4



5,6 lt

€ 36,40

T3026 | jar con base in bamboo |
jar with bamboo base |
pz. conf. 1 | c/c 4



1,7 lt

€ 15,98

T3028 | caraffa con tappo |
jug with lid
lt 1,7 | pz. conf. 1 | c/c 6



6 lt

€ 42,78

T3022 | big jar c/supporto |
big jar with tin base |
pz. conf. 1 | c/c 4



5,8 lt

€ 66,27

T3025 | big jar c/base in acacia |
jar with acacia base
pz. conf. 1 | c/c 4



1,5 lt

€ 11,75

T3027 | caraffa con tappo |
jug with lid
lt 1,5 | pz. conf. 1 | c/c 6



2,2 lt

€ 9,32

T3019 | barattolo in vetro |
glass jar with lid
cm Ø 15x24 | pz. conf. 1 | c/c 6



1,2 lt

€ 6,34

T3018 | barattolo in vetro |
glass jar with lid | cm Ø 14,8x17,3
pz. conf. 1 | c/c 12



€ 3,72

T3024 | rubinetto per jar |
tap for jar | pz. conf. 3 | c/c 48





GLASS & JAR





€ 19,00

T3010 | vasetto in vetro | glass vase
cm Ø 6x7 - 100 ml | pz. conf. 12 | c/c 4



€ 23,80

T3012 | vasetto in vetro | glass vase
cm Ø 7,5x8 - 150 ml | pz. conf. 12 | c/c 4



€ 20,70

T3011 | vasetto in vetro | glass vase
cm Ø 6,5x9 - 150 ml | pz. conf. 12 | c/c 4



€ 29,20

T3013 | vasetto in vetro | glass vase
cm Ø 8,2x8 - 200 ml | pz. conf. 12 | c/c 4



€ 14,45

T3015 | vasetto in vetro | glass vase
cm Ø 11x10 - 400 ml | pz. conf. 4 | c/c 6





beige
beige

€ 19,90

T2225.U4 | tovaglietta Trend ecopelle | Trend eco leather placement | cm 30x43 | pz. conf. 4 | c/c 10



nero
black

€ 15,90

T2224.Z4 | tovaglietta ecopelle | eco leather placement | cm 30x43 | pz. conf. 4 | c/c 10



marrone
brown

€ 19,90

T2225.R4 | tovaglietta Trend ecopelle | Trend eco leather placement | cm 30x43 | pz. conf. 4 | c/c 10



avorio
ivory

€ 15,90

T2224.U4 | tovaglietta ecopelle | eco leather placement | cm 30x43 | pz. conf. 4 | c/c 10



grigio
grey

€ 19,90

T2225.T4 | tovaglietta Trend ecopelle | Trend eco leather placement | cm 30x43 | pz. conf. 4 | c/c 10



marrone scuro
dark brown

€ 15,90

T2224.R4 | tovaglietta ecopelle | eco leather placement | cm 30x43 | pz. conf. 4 | c/c 10



nero
black

€ 22,80

T2226.Z12 | tovaglietta rotonda | round placement | cm Ø 38 | pz. conf. 12 | c/c 10



grigio
grey

€ 22,80

T2226.T12 | tovaglietta rotonda | round placement | cm Ø 38 | pz. conf. 12 | c/c 10



bronzo
bronze

€ 22,80

T2226.B12 | tovaglietta rotonda | round placement | cm Ø 38 | pz. conf. 12 | c/c 10



€ 12,21

T2218 | tovaglietta Disco | Disco placemat | cm Ø 38 | pz. conf. 4 | c/c 10







€ 30,66

T2200.P12 | tovaglietta Tundra | dark grey placemat Tundra | cm 30x45 | pz. conf. 12 | c/c 10 



€ 30,66

T2200.U12 | tovaglietta Tundra | brown placemat Tundra | cm 30x45 | pz. conf. 12 | c/c 10 



€ 15,27

T2221.P4 | tovaglietta Les Chic | placemat Les Chic cm 30x43 | pz. conf. 4 | c/c 10 



€ 15,27

T2221.Z4 | tovaglietta Les Chic | placemat Les Chic | cm 30x43 | pz. conf. 4 | c/c 10 



€ 30,66

T2214.Z12 | tovaglietta Wood | placemat Wood | cm 30x45 | pz. conf. 12 | c/c 4 



€ 3,42

S0071 | tovaglietta Sushi | Sushi placemat | cm 30x45 | pz. conf. 2 | c/c 48 



€ 30,66

T2214.P12 | tovaglietta Wood | placemat Wood | cm 30x45 | pz. conf. 12 | c/c 4 



SPECIAL PRICE

€ 7,60

T2217 | tovaglietta Mare | placemat Sea | cm 30x45 | pz. conf. 12 | c/c 10 



€ 30,66

T2214.R12 | tovaglietta Wood | placemat Wood | cm 30x45 | pz. conf. 12 | c/c 4 



€ 8,61

T2204.P | runner Savana | brown runner Savana |
cm 40x120 | pz. conf. 1 | c/c 24



€ 8,61

T2204.T | runner Savana | grey runner Savana |
cm 40x120 | pz. conf. 1 | c/c 24



€ 8,61

T2204.R | runner Savana | sand runner Savana |
cm 40x120 | pz. conf. 1 | c/c 24



€ 30,66

T2203.P12 | tovaglietta Savana | brown placemat
Savana | cm 30x45 | pz. conf. 12 | c/c 10



€ 30,66

T2203.T12 | tovaglietta Savana | grey placemat
Savana | cm 30x45 | pz. conf. 12 | c/c 10



€ 30,66

T2203.R12 | tovaglietta Savana | sand placemat
Savana | cm 30x45 | pz. conf. 12 | c/c 10





€ 7,95

T7056.R | portamenu marrone | brown menu holder | cm 25x32 - A4 | pz. conf. 1 | c/c 20



€ 7,95

T7056.Z | portamenu grigio scuro | dark grey menu holder | cm 25x32 - A4 | pz. conf. 1 | c/c 20



€ 7,95

T7056.T | portamenu grigio | grey menu holder | cm 25x32 - A4 | pz. conf. 1 | c/c 20



€ 7,95

T7056.N | portamenu rosso | red menu holder | cm 25x32 - A4 | pz. conf. 1 | c/c 20



€ 7,95

T7057 | carta dei vini rossa | red wine list | cm 25x32 - A4 | pz. conf. 1 | c/c 20



€ 9,90

T7051 | carta dei vini beige | beige wine list | cm 24x32 - A4 | pz. conf. 1 | c/c 12



€ 10,50

T7053.Z | portamenu nero | black menu holder | cm 24x32 - A4 | pz. conf. 1 | c/c 12



€ 10,50

T7054 | carta dei vini marrone | brown wine card holder | cm 24x32 - A4 | pz. conf. 1 | c/c 12



€ 7,95

T7066 | portaconto azzurro | light blue bill holder | cm 22x12,5 | pz. conf. 1 | c/c 24



portamenu/carta dei vini/portaconto
in polipropilene
per 6 fogli A4 (12 facciate)
polypropylen menu holder/wine list/
bill holder for 6
A4 sheet (12 pages)



€ 9,50

T6007.OA | numeri da tavolo 1/25 | Pa
number cardboard 1/25 | ✕
cm 8,5x5 | pz. conf. 2x25 | c/c 50



€ 9,50

T6007.OB | numeri da tavolo 26/50 | Pa
number cardboard 26/50 | cm 8,5x5
pz. conf. 2x25 | c/c 50



€ 9,50

T6007.OC | numeri da tavolo 51/75 | Pa
number cardboard 51/75 | cm 8,5x5
pz. conf. 2x25 | c/c 50



€ 10,05

T6112 | cartoncino Vintage | Pa
cardboard Vintage |
cm 8,5x5 | pz. conf. 50 | c/c 50



€ 2,75

T5228 | supporto | card stand | Ac
cm 8,5x5 | pz. conf. 1 | c/c 100



€ 9,19

S0076 | porta numero | W
number holder | cm 6x4x6 |
pz. conf. 6 | c/c 12



€ 4,32

T5076 | spillone per ordinazioni | SS
pin for orders | cm 16 |
pz. conf. 1 | c/c 12



€ 3,60

T5416 | portanumero da tavolo | SS
card holder | cm 7x20 |
pz. conf. 1 | c/c 12



€ 1,57

T5417 | portanumero da tavolo | SS
card holder | cm 5,8x6 |
pz. conf. 1 | c/c 12



autocopiante
carbonless

€ 33,50

T6004 | blocco 100 fogli | 100
sheets block | cm 10x14,5 |
pz. conf. 10 | c/c 4



€ 46,00

T6005 | comanda autocopiante
holder sheets | cm 10,2x21,4 |
pz. conf. 500 | c/c 5



€ 4,61

T7012 | porta comande | orders
folder | cm 11x23 | pz. conf. 1 |
c/c 50



€ 10,31

S0302 | lavagna con molletta | chalkboard peg |
cm 7,5x5 | pz. conf. 24 | c/c 12



€ 8,27

S0304 | mini lavagnetta | mini chalkboard
cm 5x7,5 | pz. conf. 12 | c/c 20



€ 7,85

S0303 | mini lavagnetta | mini chalkboard
cm 7,5x5 | pz. conf. 12 | c/c 20



€ 7,02

S0300 | spiedi lavagna | blackboard stick
cm 12 | pz. conf. 50 | c/c 20



€ 4,62

T5300 | pennarelli da lavagna | liquid chalks
punta cm 0,3 | pz. conf. 4 | c/c 10



€ 8,23

T5302 | pennarelli da lavagna | liquid chalks
punta cm 1 | pz. conf. 5 | c/c 10



€ 9,30

T5252 | lavagnetta windy | chalkboard Windy | cm 31x23x3 | pz. conf. 1 | c/c 24



€ 1,28

T5272 | lavagna da tavolo | table chalkboard | cm 7,3x5 | pz. conf. 1 | c/c 100



€ 1,48

T5267 | lavagna da tavolo | table chalkboard | cm 5x7,5 | pz. conf. 1 | c/c 100



€ 1,80

T5268 | lavagna da tavolo | table chalkboard | cm 7,5x5 | pz. conf. 1 | c/c 100



€ 1,91

T5271 | lavagna da tavolo | table chalkboard | cm 74x10,5 | pz. conf. 1 | c/c 100



€ 4,01

T5258 | lavagna da tavolo | table chalkboard | cm 15x23 | pz. conf. 1 | c/c 36



€ 3,40

T5270 | lavagna da tavolo | table chalkboard | cm 10,5x14,8 | pz. conf. 1 | c/c 100



€ 6,07

T5259 | lavagna da tavolo | table chalkboard | cm 21x23 | pz. conf. 1 | c/c 24



€ 5,30

T5269 | lavagna da tavolo | table chalkboard | cm 14,8x21 | pz. conf. 1 | c/c 60



€ 11,63

T5260 | lavagna da tavolo | table chalkboard cm 29x42 | conf. 1 | c/c 12



BLACKBOARD



Menu

La griglia

TURA ALLA
BRACE
NE NOSTRUM
ITALIANA!

Caffè
ALTO-BASSO-
SHAKERATO



€ 4,14

T5266 | lavagna portamenu | menu blackboard |
cm 23x32 | pz. conf. 1 | c/c 24



€ 5,75

T5255 | lavagna rettangolare | rectangular chalkboard |
cm 30x40 | pz. conf. 1 | c/c 12



€ 84,12

T5253 | lavagna bifacciale | doublesided chalkboard |
cm 50x85 | pz. conf. 1 | c/c 1



€ 142,37

T5254 | lavagna bifacciale | doublesided chalkboard |
cm 70x120 | pz. conf. 1 | c/c 1



DIVINOCAFE
ristorante - lounge cafe

Lunedì	06.00 - 02.00
Martedì	06.00 - 02.00
Mercoledì	06.00 - 02.00
Giovedì	06.00 - 02.00
Venerdì	06.00 - 02.00
Sabato	06.00 - 02.00
Domenica	06.00 - 02.00



LION dal 1960
CAFFÈ PUB

BIRRA
ARTIGIANALE
LONG DRINKS

Happy
Hour
dalle
18,00

PIATTI
FREDDI
BRUNCH
COLAZIONI
APERITIVI
PIZZA DALLE
ORE 12:00



€ 24,50

C0020.Y | candela bianca | white candle
cm Ø 5x11 | pz. conf. 9 | c/c 8



€ 24,50

C0020.0 | candela avorio | ivory candle
cm Ø 5x11 | pz. conf. 9 | c/c 8



€ 12,42

C0109.A | candeline rosa | pink candles
cm Ø 0,6x6,5 | pz. conf. 100 | c/c 25



€ 12,42

C0109.F | candeline azzurre | light blue candles |
cm Ø 0,6x6,5 | pz. conf. 100 | c/c 25



€ 10,70

C0013 | lumini scaldavivande | tealights
cm Ø 3,5x1,8 | pz. conf. 100 | c/c 8



€ 3,10

C0261 | accendino ricaricab. | rechargeable lighter |
cm 27,5 | pz. conf. 1 | c/c 48



€ 44,00

C0112.0 | candele avorio | ivory candles
cm Ø 2x25 | pz. conf. 50 | c/c 4



€ 44,00

C0112.Y | candele bianche | white candles
cm Ø 2x25 | pz. conf. 50 | c/c 4

ATMOSFERE





€ 8,12

P4000 | set beccucci punta stella | star hole tips |
cm Ø 2,5x4 | pz. conf. 6 | c/c 10



SS



€ 5,37

T4005 | tasca pasticcere | pastry bag
cm 30x16 | pz. conf. 100 | c/c 10



€ 8,12

P4001 | set beccucci punta tonda | round hole tips |
cm Ø 2,5x4 | pz. conf. 6 | c/c 10



SS



€ 9,57

T4006 | tasca pasticcere | pastry bag
cm 46x23 | pz. conf. 100 | c/c 10



€ 8,12

P4002 | set beccucci punte varie | assorted hole tips |
cm Ø 2,5x4 | pz. conf. 6 | c/c 10



SS



€ 12,88

T4007 | tasca pasticcere | pastry bag
cm 55x27 | pz. conf. 100 | c/c 108



€ 2,10

P4005 | spatola dritta | straight spatula |
cm 30 | pz. conf. 1 | c/c 10



SS



€ 2,10

P4004 | spatola a gomito | angled spatula
cm 20 | pz. conf. 1 | c/c 10



SS

PASTICCERIA





€ 5,84

S0030.Z | piattino quadrato nero | black square plate
cm 6x6 | pz. conf. 12 | c/c 100



€ 5,84

S0030 | piattino quadrato | square plate
cm 6x6 | pz. conf. 12 | c/c 100



€ 5,84

S0031.Z | piattino tondo nero | black round plate |
cm Ø 6 | pz. conf. 12 | c/c 100



€ 5,84

S0031 | piattino tondo | round plate
cm Ø 6 | pz. conf. 12 | c/c 100



€ 5,84

S0034.Z | conchiglia sushi nera | sushi black shell
plate | cm 10x3,8 | pz. conf. 12 | c/c 100



€ 5,84

S0034 | conchiglia sushi | sushi shell plate
cm 10x3,8 | pz. conf. 12 | c/c 100



€ 3,94

S0032.Z | forchettina nera | black little fork
cm 9 | pz. conf. 12 | c/c 100



€ 3,94

S0032 | forchettina | little fork
cm 9 | pz. conf. 12 | c/c 100



€ 3,94

S0033.Z | cucchiaino nero | black spoon
cm 9 | pz. conf. 12 | c/c 100



€ 3,94

S0033 | cucchiaino | spoon
cm 9 | pz. conf. 12 | c/c 100



FINGER FOOD





cm 7x5x2

S0052.S | pz. conf. 50 | c/c 40



€ 2,96



cm 9,5x5x1,5

S0041 | pz. conf. 100 | c/c 12
S0041.S | pz. conf. 50 | c/c 40



€ 9,21
€ 3,22



cm 12x7x2

S0042 | pz. conf. 100 | c/c 12
S0042.S | pz. conf. 50 | c/c 40



€ 11,12
€ 3,32



cm 15x7,5x2

S0050.S | pz. conf. 50 | c/c 40



€ 5,51



cm 17,5x8,5x2

S0043 | pz. conf. 100 | c/c 12
S0043.S | pz. conf. 50 | c/c 40



€ 13,34
€ 5,22



cm 22,5x8,5x2

S0049.S | pz. conf. 50 | c/c 40



€ 8,89



cm 25x10x2,5

S0053.S | pz. conf. 50 | c/c 20



€ 12,54



cm 28x12x2,5

S0054.S | pz. conf. 50 | c/c 20



€ 14,41





cm Ø5x2



S0044 | pz. conf. 100 | c/c 12
S0044.S | pz. conf. 50 | c/c 40

€ 15,14
€ 6,34



cm Ø4,5x4,3



S0045 | pz. conf. 100 | c/c 12
S0045.S | pz. conf. 50 | c/c 40

€ 18,00
€ 6,99



cm 33x6x8



S0075.Z | pz. conf. 2 | c/c 12

€ 11,80



cm Ø4,5x12,5



S0047 | pz. conf. 50 | c/c 12
S0047.S | pz. conf. 50 | c/c 40

€ 6,14
€ 3,57



cm Ø5,5x15,5



S0046 | pz. conf. 50 | c/c 12
S0046.S | pz. conf. 50 | c/c 40

€ 8,21
€ 4,44



cm Ø7x19,5



S0048 | pz. conf. 50 | c/c 12
S0048.S | pz. conf. 50 | c/c 40

€ 10,06
€ 5,13



cm Ø9,5x22,5



S0051.S | pz. conf. 50 | c/c 20

€ 9,03





€ 24,30

BI0923 | cannuce colorate | colored straws |
cm Ø 0,7x75 | pz. conf. 250 | c/c 12



€ 10,00

BI0913 | cannuccia imbustata | wrapped straw |
cm Ø 0,5x24 | pz. conf. 400 | c/c 16



€ 11,80

BI0922.Y | cannuccia bianca | white straw |
cm Ø 0,7x21 | pz. conf. 500 | c/c 20



€ 11,80

BI0922.Z | cannuccia nera | black straw |
cm Ø 0,7x21 | pz. conf. 500 | c/c 20



€ 10,90

BI0921.Z | cannuccia PLA nera | PLA black straw |
cm Ø 0,7x16 | pz. conf. 500 | c/c 30



€ 9,30

BI0920.Z | cannuccia nera | black straw |
cm Ø 0,7x14,5 | pz. conf. 500 | c/c 20



€ 9,30

BI0920.Y | cannuccia bianca | white straw |
cm Ø 0,7x14,5 | pz. conf. 500 | c/c 20



€ 7,06

BI0929 | cannuccia paletta nera | black spoon straw 
cm Ø 0,6x21 | pz. conf. 250 | c/c 24





€ 7,90

B943 | cannuccia verde | green straw
cm Ø 0,6x21 | pz. conf. 250 | c/c 12



€ 8,06

B949.S | cannuccia nera | black straw
cm Ø 0,7x21 | pz. conf. 250 | c/c 16



€ 7,14

B948.S | cannuccia nera | black straw
cm Ø 0,7x15 | pz. conf. 250 | c/c 28



€ 11,78

B950 | cannuccia imbustata | wrapped straw
cm Ø 0,7x21 | pz. conf. 250 | c/c 12



€ 8,06

B946.S | cannuccia kraft | brown straw
cm Ø 0,7x21 | pz. conf. 250 | c/c 16



€ 6,12

B947.S | cannuccia kraft | brown straw
cm Ø 0,7x15 | pz. conf. 250 | c/c 28



€ 7,90

B941.S | cannuccia colorata | mix color straw
cm Ø 0,6x21 | pz. conf. 250 | c/c 24



€ 8,67

B940.S | cannuccia imbustata | wrapped straw
cm Ø 0,6x21 | pz. conf. 250 | c/c 18



€ 7,65

B951 | cannuccia bianca | white straw
cm Ø 0,7x21 | pz. conf. 250 | c/c 12



€ 10,60

B952 | cannuccia imbustata | wrapped straw |
cm Ø 0,7x21 | pz. conf. 250 | c/c 12





Deco € 3,17

S0012.2 | cm 15 |
pz. conf. 100 | c/c 50



Deco € 2,88

S0011.2 | cm 10,5 |
pz. conf. 100 | c/c 50



Deco € 2,60

S0008 | cm 7 | pz.
conf. 100 | c/c 50



Deco € 3,71

S0012.Z | cm 15 |
pz. conf. 100 | c/c 50



Deco € 3,66

S0011.Z | cm 10,5 |
pz. conf. 100 | c/c 50



Twister € 2,90

S0305 | spiedo | stick
cm 15 | pz. conf. 100 |
c/c 100



Twister € 2,90

S0306 | spiedo nero |
black stick | cm 10 |
pz. conf. 100 | c/c 100



Ricciolo € 4,44

S0015 | spiedo | stick
cm 12 | pz. conf. 100 |
c/c 50



Ricciolo € 5,06

S0015.Z | spiedo nero |
black stick | cm 12 |
pz. conf. 100 | c/c 50



Cuore € 5,73

S0029.Z | spiedo |
stick | cm 15 | pz. conf.
100 | c/c 50



Spade in bamboo | bamboo paddles



cm 25 | pz. conf. 100 | c/c 50
S0014 | scatola | box | € 3,44
S0014S | sacchetto | bag | € 2,39



cm 20 | pz. conf. 100 | c/c 50
S0017 | scatola | box | € 2,80
S0017S | sacchetto | bag | € 1,86



cm 15 | pz. conf. 100 | c/c 50
S0007.2 | scatola | box | € 2,42
S0007S | sacchetto | bag | € 1,62



cm 12 | pz. conf. 100 | c/c 50
S0024 | scatola | box | € 1,91



cm 9 | pz. conf. 100 | c/c 50
S0010.2 | scatola | box | € 1,81
S0010S | sacchetto | bag | € 1,31



Kurvi € 5,90
S0016 | naturale | natural | cm 12 | pz. conf. 100 | c/c 50



Kurvi € 5,90
S0016.Z | nero | black | cm 12 | pz. conf. 100 | c/c 50



Kurvi € 5,90
S0016.M | rosso | red | cm 12 | pz. conf. 100 | c/c 50



Reiko € 5,90
S0018 | spiedi Reiko | sticks Reiko | cm 9 | pz. conf. 100 | c/c 100



forchettina | small fork
B2 | pz. 1000 | c/c 20 | € 11,95
S0019 | pz. 500 | c/c 20 | € 7,19
S0021 | pz. 100 | c/c 100 | € 1,20





Cuore € 5,90 NEW
S2006 | cm 12 |
 pz. conf. 100 | c/c 50

Flower € 5,90 NEW
S2009 | cm 12 |
 pz. conf. 100 | c/c 50

Smile € 5,90 NEW
S2007 | cm 12 |
 pz. conf. 100 | c/c 50

Chili € 5,90 NEW
S2008 | cm 12 |
 pz. conf. 100 | c/c 50

Cactus € 5,90
S2003 | spiedi | sticks
 | cm 12 | pz. conf. 100
 | c/c 50



Maori € 5,90
S2001 | spiedi | sticks
 | cm 12 | pz. conf. 100
 | c/c 50



Mustache € 5,90
S2005 | spiedi | sticks
 | cm 12 | pz. conf. 100
 | c/c 50



Kyoto € 3,61
S0026 | spiedi | sticks
 | cm 15 | pz. conf. 50 |
 c/c 50



Kyoto € 3,41
S0025 | spiedi | sticks
 | cm 10 | pz. conf. 50 |
 c/c 50



Osaka € 2,24
S0027 | spiedo | stick
 | cm 9 | pz. conf. 50 |
 c/c 50





Akita € 2,86

S0028 | spiedi | sticks |
cm 9 | pz. conf. 100 |
c/c 50

Sfera € 3,43

S0009.2 | spiedi |
sticks | cm 15 |
pz. conf. 100 | c/c 50



Chiba € 4,25

S0039 | fermaboccone | double stick
| cm 5 | pz. conf. 100 | c/c 50



€ 5,90

S0022 | pinze shushi | sushi pliers |
cm 8 | pz. conf. 50 | c/c 50



**Cotton
candy**

€ 1,13

SP1 | bastoncino |
stick | cm Ø 0,5x40 |
pz. conf. 50 | c/c 50



€ 9,68

SP5S | cm Ø 0,3x25 |
pz. conf. 1000 | c/c 10



€ 7,94

SP4S | cm Ø 0,3x20 |
pz. conf. 1000 | c/c 10



€ 6,14

SP3S | cm Ø 0,25x20 |
pz. conf. 1000 | c/c 10



€ 5,18

SP2S | cm Ø 0,25x15 |
pz. conf. 1000 | c/c 10

Spiedi in bamboo | bamboo skewers





€ 4,64

S0037.P | bacchette sushi |
sushi chopsticks | cm 21
pz. conf. 100 | c/c 10



€ 5,46

S0037.T | bacchette sushi |
sushi chopsticks | cm 21
pz. conf. 100 | c/c 10



€ 4,64

S0037.Z | bacchette sushi |
sushi chopsticks | cm 21
pz. conf. 100 | c/c 10



€ 4,64

S0037 | bacchette sushi |
sushi chopsticks | cm 21
pz. conf. 100 | c/c 10



€ 7,85

S0107 | portastuzzicadenti | to-
othpicks holder | cm 3,5x3,5x4,5
| pz. conf. 6 | c/c 12



€ 9,13

S0106 | portastuzzicadenti |
toothpicks holder | cm Ø
3,5x4,5 | pz. conf. 6 | c/c 12



€ 17,31

S0077.Z | supporto spiedini
nero | black skewer holder | cm
24x10x2 | pz. conf. 3 | c/c 24



€ 16,81

S0077 | supporto spiedini |
skewer holder | cm 24x10x2 |
pz. conf. 3 | c/c 24



€ 4,95

S0035.F | forchetta in bamboo bamboo fork |
cm 14 | pz. conf. 12 c/c 36



SPECIAL PRICE

€ 3,47

S0035.K | coltello in bamboo bamboo knife |
cm 14 | pz. conf. 12 c/c 36



€ 4,95

S0035.S | cucchiaio in bamboo bamboo spoon |
cm 14 | pz. conf. 12 c/c 36



€ 4,22

H1611 | carta per vaporiera | steamer cooking paper |
cm Ø 11 | pz. conf. 250 | c/c 8



€ 6,99

S0110.R | base per vaporiera | steamer bamboo base |
cm Ø 20 | pz. conf. 1 | c/c 36



€ 4,42

S0109.R | base per vaporiera | steamer bamboo base |
cm Ø 13 | pz. conf. 1 | c/c 36



€ 13,80

S0110 | vaporiera in bamboo | bamboo steamer |
cm Ø 20 | pz. conf. 1 | c/c 12



€ 9,55

S0109 | vaporiera in bamboo | bamboo steamer |
cm Ø 13 | pz. conf. 1 | c/c 24





€ 1,59

SK1 | stuzzicadenti sfusi 1 punta | 1 point toothpicks
| cm 7 | pz. conf. 1000 | c/c 50



€ 0,41

L102 | stuzzicadenti | box toothpicks
cm 7 | pz. conf. 200 | c/c 288



€ 1,08

L103 | stuzzicadenti imb. | wrap. toothpicks
cm 7 | pz. conf. 200 | c/c 144



€ 1,13

L101 | stuzzicadenti barattolo | jar toothpicks
cm 7 | pz. conf. 500 | c/c 150



€ 7,30

S0006 | stuzzicadenti frills | toothpicks frills
cm 11 | pz. conf. 1000 | c/c 10



€ 6,10

S0005 | stuzzicadenti frills | toothpicks frills
cm 7 | pz. conf. 1000 | c/c 10



betulla brick

€ 3,59

L1 | stuzzicadenti imb. | wrap. toothpicks
cm 7 | pz. conf. 1000 | c/c 208



bamboo

€ 4,85

L2 | stuzzicadenti imb. | wrap. toothpicks
cm 7 | pz. conf. 1000 | c/c 20



Fiesta lux

€ 12,00

B36L.1 | palma | palm |
cm 20 | pz. conf. 100 | c/c 100



Fiesta lux

€ 12,00

B36.1 | palma | palm |
cm 15 | pz. conf. 100 | c/c 10



Fiesta

€ 6,74

B36S | palma | palm |
cm 15 | pz. conf. 144 | c/c 10



€ 6,36

B1S | ombrellino cocktail | cocktail
brella | cm Ø 8x8,5 | pz. conf. 144 | c/c
10



€ 21,50

B051 | dalia | dalia |
cm Ø 9x24 | pz. conf. 100 | c/c
10



€ 3,24

SB1M.2 | bandierine miste |
mixed flags sticks | cm 7 |
pz. conf. 250 | c/c 40





€ 5,50

Q1041 | marcatore "vegetariano" | wood marker "vegetarian" | cm 9 | pz. conf. 250 | c/c 20



€ 5,82

Q1023 | paletta imbustata | wrapped coffee stirrer | cm 9x0,6x0,13 | pz. conf. 500 | c/c 20



€ 5,50

Q1040 | marcatore "vegan" | wood marker "vegan" | cm 9 | pz. conf. 250 | c/c 20



€ 6,35

Q1025 | paletta imbustata | wrapped coffee stirrer | cm 11x0,6x0,13 | pz. conf. 500 | c/c 20



€ 5,50

Q1042 | marcatore "senza glutine" | wood marker "gluten free" | cm 9 | pz. conf. 250 | c/c 20



€ 7,72

S0020 | forchettina legno | wooden small fork | cm 9 | pz. conf. 1000 | c/c 20



€ 5,50

Q1020 | marcatore "al sangue" | wood marker "rare" | cm 9 | pz. conf. 250 | c/c 20



€ 2,96

Q1027 | forchettina pesce | fish small fork | cm 9,5 | pz. conf. 250 | c/c 40



€ 5,50

Q1021 | marcatore "medio" | wood marker "medium" | cm 9 | pz. conf. 250 | c/c 20



€ 4,42

Q1019 | marcatore in legno | wooden marker | cm 8 | pz. conf. 250 | c/c 10



€ 5,50

Q1022 | marcatore "ben cotto" | wood marker "well" | cm 9 | pz. conf. 250 | c/c 20



€ 10,30

Q1028 | miscelatore | cocktail stirrer | cm 15x0,2,8 | pz. conf. 250 | c/c 10







€ 3,49

Q1031 | coltello imbustato | wrapped knife |
cm 16 | pz. conf. 48 | c/c 10



€ 1,90

Q1011 | coltello in legno | wooden knife |
cm 16 | pz. conf. 48 | c/c 24



€ 6,00

Q1032 | forchetta imbustata | wrapped fork |
cm 16 | pz. conf. 48 | c/c 10



€ 2,40

Q1013 | forchetta in legno | wooden fork |
cm 16 | pz. conf. 48 | c/c 24



€ 6,85

Q1033 | cucchiaino imbustato | wrapped spoon |
cm 16 | pz. conf. 48 | c/c 10



€ 2,50

Q1012 | cucchiaino in legno | wooden spoon |
cm 16 | pz. conf. 48 | c/c 24



€ 8,50

Q1015 | bis posate in legno | wood cutlery set |
cm 16 | pz. conf. 48 | c/c 10



€ 1,55

Q1014 | cucchiaino in legno | wooden teaspoon |
cm 9,5 | pz. conf. 48 | c/c 24



€ 11,10

Q1030 | tris posate in legno | wooden cutlery set |
cm 16 | pz. conf. 48 | c/c 10



€ 1,95

Q1016 | cucchiaino da gelato | ice cream spoon |
cm 9,5x1,7x0,15 | pz. conf. 48 | c/c 24



€ 2,30

Q1018 | forchettina in legno | wooden fork |
cm 10,5x2,5x0,12 | pz. conf. 48 | c/c 24



€ 2,30

Q1017 | cucchiaino in legno | wooden teaspoon |
cm 10x2,8x0,15 | pz. conf. 48 | c/c 24



NATURALE





€ 4,03

S0059 | mini tagliere rettangolare | mini rect. cutting board | cm 6x10 | pz. conf. 24 | c/c 24



€ 4,03

S0058 | mini tagliere rotondo | mini round cutting board | cm Ø 8 | pz. conf. 24 | c/c 24



€ 9,91

Q1001 | piatto ovale | oval plate | cm 21x14x2 | pz. conf. 24 | c/c 12



€ 8,60

Q1007 | vassoio rettangolare | rectangular tray | cm 21x10,5x3 | pz. conf. 24 | c/c 12





€ 5,13

Q6014 | piatto quadrato | square plate |
cm 14x14 | pz. conf. 12 | c/c 12



€ 5,77

Q6013 | piatto ovale | oval plate |
cm 19x13 | pz. conf. 12 | c/c 12



€ 9,72

Q6017 | piatto barca | boat plate |
cm 30x14 | pz. conf. 12 | c/c 12



€ 7,20

Q6016 | piatto rettangolare | rectangular plate |
cm 27x10 | pz. conf. 12 | c/c 12



€ 12,64

Q6015 | piatto barca | boat plate |
cm 33x24 | pz. conf. 12 | c/c 12



€ 10,14

Q6012 | piatto ovale | oval plate |
cm 28,5x20 | pz. conf. 12 | c/c 12





Q6011 | ciotola | bowl |
cm Ø 6 | pz. conf. 12 | c/c 12

€ 3,04



Q6006 | piatto rotondo | round plate
cm Ø 17 | pz. conf. 12 | c/c 24

€ 4,34



Q6010 | ciotola | bowl |
cm Ø 9 | pz. conf. 12 | c/c 12

€ 3,50



Q6005 | piatto rotondo | round plate
cm Ø 23 | pz. conf. 12 | c/c 12

€ 6,96



Q6009 | ciotola | bowl |
cm Ø 15 | pz. conf. 12 | c/c 12

€ 7,33



Q6004 | piatto rotondo | round plate
cm Ø 26 | pz. conf. 12 | c/c 12

€ 7,77





€ 2,87

Q6003 | piatto quadrato | square plate
cm 10x10 | pz. conf. 12 | c/c 12



€ 5,44

Q6001 | piatto quadrato | square plate
cm 20x20 | pz. conf. 12 | c/c 12



€ 3,91

Q6002 | piatto quadrato | square plate
cm 15x15 | pz. conf. 12 | c/c 24



€ 5,14

Q6008 | vassoio rettangolare | rectangular tray |
cm 16x13,5 | pz. conf. 12 | c/c 12



€ 7,77

Q6000 | piatto quadrato | square plate
cm 25,5x25,5 | pz. conf. 12 | c/c 2



€ 5,83

Q6007 | vassoio rettangolare | rectangular tray |
cm 24,5x15,5 | pz. conf. 12 | c/c 12





€ 4,75

Q2020 | ciotola | bowl | cm Ø 16x4 - 350 ml |
pz. conf. 50 | c/c 20



€ 12,80

Q2089 | coperchio | lid
cm 16,3x16,3x4 | pz. conf. 50 | c/c 8



€ 7,65

Q2021 | piatto fondo | soup plate
cm Ø 19x4 - 680 ml | pz. conf. 50 | c/c 10



€ 5,85

Q2088 | piatto quadrato | square plate
cm 16x16 | pz. conf. 50 | c/c 8



€ 3,34

Q2010 | piatto tondo | round plate
cm Ø 16 | pz. conf. 50 | c/c 20



€ 5,05

Q2017 | piatto quadrato | square plate
cm 16x16 | pz. conf. 50 | c/c 10



€ 4,27

Q2011 | piatto tondo | round plate
cm Ø 18 | pz. conf. 50 | c/c 20



€ 9,30

Q2018 | piatto quadrato | square plate
cm 20x20 | pz. conf. 50 | c/c 10



€ 6,35

Q2012 | piatto tondo | round plate
cm Ø 22,5 | pz. conf. 50 | c/c 10



€ 16,69

Q2025 | piatto quadrato | square plate
cm 26x26 | pz. conf. 50 | c/c 10



€ 9,63

Q2013 | piatto tondo | round plate
cm Ø 26 | pz. conf. 50 | c/c 10



€ 8,75

Q2019 | piatto rettangolare | rectangular plate |
cm 25x13 | pz. conf. 50 | c/c 10





€ 14,42

Q2087 | coperchio ovale | oval lid
cm 32x25x5 | pz. conf. 25 | c/c 4



€ 6,95

Q2014 | piatto ovale | oval plate
cm 26x19 | pz. conf. 50 | c/c 10



€ 12,82

Q2015 | piatto ovale | oval plate
cm 32x25 | pz. conf. 50 | c/c 10



€ 10,40

Q2016 | piatto 3 scomparti | 3 compartments plate |
cm Ø 26 | pz. conf. 50 | c/c 10



€ 18,18

Q2072 | piatto pizza | pizza plate
cm Ø 34 | pz. conf. 25 | c/c 6





€ 5,25

Q2065 | piatto fondo quadrato | soup square plate |
cm 15x4 | pz. conf. 50 | c/c 10



€ 6,15

Q2063 | ciotola tonda | round bowl
cm Ø 13,5x4,6 - 350 ml | pz. conf. 50 | c/c 20



€ 8,32

Q2062 | ciotola tonda | round bowl
cm Ø 15,5x5,4 - 500 ml | pz. conf. 50 | c/c 20



€ 8,90

Q2070 | piatto ovale | oval plate
cm 20,5x14,5x4 - 500 ml | pz. conf. 50 | c/c 5



€ 9,75

Q2061 | ciotola tonda | round bowl
cm Ø 17,2x6,3 - 800 ml | pz. conf. 50 | c/c 10



€ 12,80

Q2116 | coperchio tondo | round lid
cm Ø 17x3,5 | pz. conf. 50 | c/c 8



€ 21,13

Q2060.C | coperchio in RPET | RPET lid
cm Ø 19,5 | pz. conf. 50 | c/c 8



€ 6,35

Q2125 | ciotola tonda | round bowl
cm Ø 15,5x5,4 - 500 ml | pz. conf. 50 | c/c 20



€ 13,45

Q2069 | piatto fondo | soup plate
cm Ø 19,5x5 - 500 ml | pz. conf. 50 | c/c 8



€ 14,55

Q2078 | coperchio in pet | pet lid
cm Ø 18 | pz. conf. 50 | c/c 8



€ 17,54

Q2060 | ciotola tonda | round bowl
cm Ø 19,5x7,5 - 900 ml | pz. conf. 50 | c/c 8



€ 13,15

Q2077 | ciotola | bowl | cm Ø 17,5x6,7 - 950 ml |
pz. conf. 50 | c/c 8





€ 10,80

Q2081 | ciotola ovale | oval bowl
cm 20,3x13,5x4 - 550 ml | pz. conf. 50 | c/c 6



€ 13,49

Q2082 | coperchio ovale | oval lid
cm 21x14x3,5 | pz. conf. 50 | c/c 6



€ 18,45

Q2079 | ciotola ovale | oval bowl
cm 23,6x17x4 - 750 ml | pz. conf. 50 | c/c 6



€ 16,55

Q2080 | coperchio ovale | pet oval lid
cm 24x17x3,5 | pz. conf. 50 | c/c 4



€ 14,85

Q2071 | piatto ovale | oval plate
cm 26x20x4,5 - 900 ml | pz. conf. 50 | c/c 5



€ 21,40

Q2086 | coperchio ovale | oval lid
cm 26,9x20,4x4,9 | pz. conf. 50 | c/c 4





€ 13,53

Q2111 | sandwich box | sandwich box
cm 18x12x7 - 1300 ml | pz. conf. 50 | c/c 8



€ 9,00

Q2022 | hamburger box | hamburger box
cm 15x15x8,5 - 800 ml | pz. conf. 50 | c/c 10



€ 12,60

Q2023 | sandwich box | sandwich box
cm 23x15x8 - 1400 ml | pz. conf. 50 | c/c 6



€ 12,02

Q2112 | hamburger box | hamburger box
cm 19x20,5x10 - 3500 ml | pz. conf. 25 | c/c 8



€ 12,84

Q2113 | hamburger box | hamburger box
cm 23x22x9,5 - 4300 ml | pz. conf. 25 | c/c 8





€ 6,80

Q2117 | vassoio sushi | sushi tray
cm 22x9,2x2 | pz. conf. 50 | c/c 10



€ 10,20

Q2121 | coperchio | lid
cm 22,4x9,55x3,2 | pz. conf. 50 | c/c 10



€ 10,20

Q2118 | vassoio sushi | sushi tray
cm 18,4x12,8x2 | pz. conf. 50 | c/c 8



€ 11,65

Q2122 | coperchio | lid
cm 18,8x13x3,2 | pz. conf. 50 | c/c 8



€ 11,00

Q2119 | vassoio sushi | sushi tray
cm 21,5x13,5x2 | pz. conf. 50 | c/c 8



€ 14,05

Q2123 | coperchio | lid
cm 22x14x3,2 | pz. conf. 50 | c/c 8



€ 11,85

Q2120 | vassoio sushi | sushi tray
cm 23,7x14,5x2 | pz. conf. 50 | c/c 6



€ 16,10

Q2124 | coperchio | lid
cm 24x15x3,2 | pz. conf. 50 | c/c 6





€ 8,94

Q2103 | coperchio ovale | cellulose lid
cm 24,5x14x1 | pz. conf. 50 | c/c 6



€ 7,25

Q2110 | coperchio rettangolare | rectangular lid |
cm 23,5x18,5x2,5 | pz. conf. 40 | c/c 6



€ 8,95

Q2101 | vaschetta ovale | oval bowl
cm 23,5x13,1x7 - 1000 ml | pz. conf. 50 | c/c 6



€ 6,55

Q2107 | vaschetta rettangolare | rectangular tray |
cm 22x17x3,5 - 850 ml | pz. conf. 40 | c/c 6



€ 7,90

Q2099 | vaschetta ovale | oval bowl
cm 23,5x13x4 - 850 ml | pz. conf. 50 | c/c 6



€ 8,25

Q2108 | vaschetta rettangolare | rectangular tray |
cm 22x17x5 - 1100 ml | pz. conf. 40 | c/c 6



€ 7,95

Q2102 | vaschetta 2 scomparti | 2 compartment
tray | cm 23,5x13x7 - 1000 ml | pz. conf. 50 | c/c 6



€ 10,00

Q2109 | vaschetta rettangolare | rectangular tray |
cm 22x17x7 - 1300 ml | pz. conf. 40 | c/c 6



€ 7,30

Q2100 | vaschetta 2 scomparti | 2 compartment
tray | cm 23,5x13x4 - 850 ml | pz. conf. 50 | c/c 6



SPECIAL PRICE

€ 8,25

Q2083 | ciotola rettangolare | rectangular bowl |
cm 23x18x4,3 - 1100 ml | pz. conf. 50 | c/c 4



€ 20,05

Q2085 | coperchio | lid
cm 23,5x18,5x1,5 | pz. conf. 50 | c/c 4



SPECIAL PRICE

€ 12,30

Q2084 | ciotola rettangolare | rectangular bowl |
cm 23x18x7,7 - 1800 ml | pz. conf. 50 | c/c 4







Q2092 | coperchio | lid
cm 26,3x13,5x1,5 | pz. conf. 40 | c/c 6

€ 7,60



Q2024 | vaschetta chips | chips tray
cm 17x12x4 -500 ml | pz. conf. 50 | c/c 10

€ 6,65



Q2091 | vaschetta 3 scomparti | 3 compartment tray | cm 25,8x13x6 | pz. conf. 40 | c/c 6

€ 9,10



Q2068 | vassoio rettangolare | rectangular tray | cm 18,5x13,5x2,3 | pz. conf. 50 | c/c 20

€ 5,75



Q2106 | coperchio | lid
cm 18,5x12,5x1,5 | pz. conf. 50 | c/c 6

€ 4,90



Q2067 | vassoio rettangolare | rectangular tray | cm 22,5x13,5x2,3 | pz. conf. 50 | c/c 10

€ 8,35



Q2104 | vaschetta rettangolare | rectangular tray | cm 18x12x5 - 650 ml | pz. conf. 50 | c/c 6

€ 8,35



Q2066.C | coperchio in RPET | RPET lid
cm 23,7x16,3x2,7 | pz. conf. 50 | c/c 10

€ 22,75



Q2105 | vaschetta rettangolare | rectangular tray | cm 18x12x7 - 950 ml | pz. conf. 50 | c/c 6

€ 11,15



Q2066 | vaschetta rettangolare | rectangular deep tray | cm 23x15,5x4,5 - 800 ml | pz. conf. 50 | c/c 10

€ 14,70







€ 16,65

Q2076 | coperchio quadrato in PET | PET square lid | cm 18,5x18,5 | pz. conf. 50 | c/c 4



€ 23,10

Q2075 | ciotola quadrata | square bowl | cm 18x18x9 - 1200 ml | pz. conf. 50 | c/c 6



€ 16,85

Q2074 | ciotola quadrata | square bowl | cm 18x18x7,5 - 950 ml | pz. conf. 50 | c/c 6



€ 16,25

Q2073 | ciotola quadrata | square bowl | cm 18x18x6 - 700 ml | pz. conf. 50 | c/c 6



€ 6,15

Q2090 | vaschetta con salsiera | tray with sauce holder | cm 21,8x16,5x4,5 | pz. conf. 25 | c/c 8



€ 15,47

Q2095 | vassoio 3 scomparti | 3 compartment tray | cm 24x22x4 | pz. conf. 25 | c/c 4



€ 4,14

Q2004 | ciotolina finger food polpa | finger food bowl | cm Ø4xØ6x3 | pz. conf. 50 | c/c 20



€ 7,27

Q2008 | ciotolina finger food polpa | finger food bowl | cm 8x8x3 | pz. conf. 50 | c/c 20



€ 8,78

Q2009 | ciotolina finger food polpa | finger food bowl | cm 8x8x4,5 | pz. conf. 50 | c/c 20



SPECIAL PRICE

€ 3,34

Q2005 | vassoietto finger food | finger food tray | cm 14x8,1x2,2 | pz. conf. 50 | c/c 20



€ 22,75

Q2066.C | coperchio in RPET | RPET lid | cm 23,7x16,3 | pz. conf. 50 | c/c 20



€ 7,89

Q2096 | coperchio | lid | cm 24,5x22,5x1,5 | pz. conf. 25 | c/c 4





SPECIAL PRICE

€ 2,56

Q2059 | cucchiaino in polpa | cellulose pulp spoon |
cm 16 | pz. conf. 50 | c/c 20



SPECIAL PRICE

€ 2,56

Q2058 | forchetta in polpa | cellulose pulp
fork | cm 16 | pz. conf. 50 | c/c 20



SPECIAL PRICE

€ 2,56

Q2057 | coltello in polpa | cellulose pulp
knife | cm 16 | pz. conf. 50 | c/c 20



€ 7,45

Q2064 | ciotola con coperchio | mini bowl with lid |
cm Ø 6,8x3 - 59 ml | pz. conf. 50 | c/c 10



€ 5,63

Q2031 | bicchierino | small cup
cm Ø 7,5x5 - 150 ml | pz. conf. 50 | c/c 20



€ 6,62

Q2030 | bicchiere | cup
cm Ø 8x9 - 240 ml | pz. conf. 50 | c/c 20





€ 11,82

Q2034 | cucchiaino finger food | finger food spoon |
cm 5x10 | pz. conf. 100 | c/c 10



€ 5,73

Q2003 | cucchiaino finger food | finger food spoon |
cm 12,4x2,7x0,6/2,7 | pz. conf. 50 | c/c 20



€ 5,73

Q2002 | piattino finger food | finger food plate |
cm 11x5,2x3 | pz. conf. 50 | c/c 20



€ 5,73

Q2000 | foglia finger food | finger food leaf |
cm Ø9x6x1,2 | pz. conf. 50 | c/c 20



€ 9,32

Q2036 | ciotolina finger food | finger food cup |
cm Ø 7,2x3 | pz. conf. 50 | c/c 10



€ 7,06

Q2035 | piattino finger food | finger food plate | cm
6,5x6,5x1 | pz. conf. 50 | c/c 10



€ 5,73

Q2001 | piattino finger food | finger food plate |
cm 8x4,8x1,2/2,7 | pz. conf. 50 | c/c 20



€ 7,06

Q2037 | piattino finger food | finger food plate |
cm Ø 7,2x1 | pz. conf. 50 | c/c 10



€ 5,02

Q2006 | vassoietto finger food | finger food shape |
cm 13x11,6x1,2 | pz. conf. 50 | c/c 20



€ 5,56

Q2007 | vassoietto finger food | finger food tray |
cm 10x10x2 | pz. conf. 50 | c/c 20







SPECIAL PRICE

€ 7,78

Q5000.K | piatto tondo | round plate
cm Ø 18 | pz. conf. 100 | c/c 10



SPECIAL PRICE

€ 7,69

Q5030.K | ciotola tonda | round bowl
cm Ø 19 | pz. conf. 50 | c/c 12



SPECIAL PRICE

€ 11,07

Q5001.K | piatto tondo | round plate
cm Ø 23 | pz. conf. 100 | c/c 5



SPECIAL PRICE

€ 14,09

Q5015.K | vassoio rettangolare | rectangular tray |
cm 13x20 | pz. conf. 250 | c/c 6





SPECIAL PRICE

€ 9,59

Q5100.K | piatto tondo | round plate
cm Ø 18 | pz. conf. 100 | c/c 10



SPECIAL PRICE

€ 11,10

Q5130.K | ciotola tonda | round bowl
cm Ø 19 | pz. conf. 50 | c/c 12



SPECIAL PRICE

€ 13,36

Q5101.K | piatto tondo | round plate
cm Ø 23 | pz. conf. 100 | c/c 5



SPECIAL PRICE

€ 18,50

Q5110 | piatto quadrato | square plate
cm 20x20 | pz. conf. 100 | c/c 5



SPECIAL PRICE

€ 19,10

Q5115.K | vassoio rettangolare | rectangular tray |
cm 13x20 | pz. conf. 250 | c/c 6





€ 16,14

H0747.V | box fritti vintage | vintage fries box | cm 21x14x10,3 - 3000 ml | pz. conf. 25 | c/c 6



€ 12,64

H0719 | hamburger box | hamburger box | cm 10,5x10,5x8,5 - 950 ml | pz. conf. 50 | c/c 4



€ 10,15

H0746.V | box fritti vintage | vintage fries box | cm 19x11x7 - 1300 ml | pz. conf. 25 | c/c 60



€ 14,58

H0707 | hamburger box | hamburger box | cm 12x12x7 - 800 ml | pz. conf. 50 | c/c 4



€ 21,50

H0712.V | box take away | take away box | cm 21x16x9 - 2500 ml | pz. conf. 40 | c/c 4



€ 22,36

H0708.V | hamburger box | hamburger box | cm 16x16x9 - 1800 ml | pz. conf. 50 | c/c 4



€ 14,60

H0711 | box take away | take away box | cm 13x9x6,4 - 750 ml | pz. conf. 50 | c/c 9



€ 22,36

H0708 | hamburger box | hamburger box | cm 16x16x9 - 1800 ml | pz. conf. 50 | c/c 4



€ 19,60

H0727 | box take away | take away box | cm 19,5x9x6 - 1200 ml | pz. conf. 50 | c/c 4



€ 21,50

H0712 | box take away | take away box | cm 21x16x9 - 2500 ml | pz. conf. 40 | c/c 4





1914
GRAINS
No 4
GRAINS
de Bouve
RICHEST CASH PRICE PAID FOR GRAIN
YORK, PA.



€ 6,90

H0701 | cono da fritti | fries cone |
cm 7x7x17,5 - 200 ml | pz. conf. 50 | c/c 10



€ 18,55

H0724 | hamburger box | hamburger box |
cm 19x11x7 - 1200 ml | pz. conf. 50 | c/c 4



SPECIAL PRICE



€ 8,70

H0702 | cono da fritti | fries cone |
cm 9,5x9,5x22,5 - 500 ml | pz. conf. 50 | c/c 10



€ 13,53

H0710 | box take away | take away box |
cm 9,8x8,5x9,2 - 750 ml | pz. conf. 50 | c/c 10

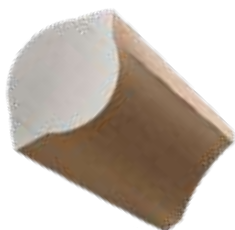

€ 11,95

H0705 | box fritti | fries box |
cm 10,5x10,5x5,5 - 150 ml | pz. conf. 100 | c/c 10



€ 6,90

H0725 | box fritti | fries box |
cm Ø 64x14,5 - 470 ml | pz. conf. 50 | c/c 10



SPECIAL PRICE



€ 13,40

H0706 | box fritti | fries box |
cm 13x13x5,5 - 250 ml | pz. conf. 100 | c/c 10



€ 7,40

H0726 | box fritti | fries box |
cm Ø 64x17,6 - 620 ml | pz. conf. 50 | c/c 10



€ 6,61

H0757 | bicchiere fritti | fries cup |
cm 6x6,3x12 - 180 ml | pz. conf. 50 | c/c 20



TAKEAWAY





SPECIAL PRICE

€ 6,69

H0752 | vaschetta fritti | fries tray |
cm 13x8,5x3,5 - 200 ml | pz. conf. 125 | c/c 8



€ 26,18

H0713 | sandwich box | sandwich box |
cm 12,3x7,2x12,3 | pz. conf. 100 | c/c 5



SPECIAL PRICE

€ 9,14

H0753 | vaschetta fritti | fries tray |
cm 15x10,5x3,7 - 300 ml | pz. conf. 125 | c/c 8



SPECIAL PRICE

€ 6,48

H0751 | vaschetta fritti | fries tray |
cm 11,1x7,5x3 - 100 ml | pz. conf. 125 | c/c 8



SPECIAL PRICE

€ 9,36

H0754 | vaschetta fritti | fries tray |
cm 16,5x13,5x4,3 - 400 ml | pz. conf. 125 | c/c 4



€ 10,70

H0704 | vaschetta fritti | fries tray |
cm 13x9,5x4,8 - 400 ml | pz. conf. 100 | c/c 10



SPECIAL PRICE

€ 14,47

H0755 | vaschetta fritti | fries tray |
cm 19,5x16,5x5,5 - 700 ml | pz. conf. 125 | c/c 4



€ 12,75

H0703 | vaschetta fritti | fries tray |
cm 18x12x4 - 500 ml | pz. conf. 100 | c/c 10



SPECIAL PRICE

€ 16,28

H0756 | vaschetta fritti | fries tray |
cm 23x18,5x5,7 - 1100 ml | pz. conf. 125 | c/c 4



20,08

H0714 | vaschetta fritti | fries tray |
cm 25,6x16,7x4 - 800 ml | pz. conf. 100 | c/c 4





STREET FOOD



SPECIAL PRICE

€ 6,07



H0773 | coperchio pp | pp lid
cm 17x17 | pz. conf. 24 | c/c 15



SPECIAL PRICE

€ 3,69



H0768 | coperchio pp | pp lid
cm 17,3x12,3 | pz. conf. 24 | c/c 15



SPECIAL PRICE

€ 7,45



H0769 | vaschetta insalatiera | salad bowl
ml 750 | cm 17x17x44 | pz. conf. 24 | c/c 15



SPECIAL PRICE

€ 5,26



H0765 | vaschetta insalatiera | salad bowl
ml 500 | cm 17,3x12,3x4 | pz. conf. 24 | c/c 15



SPECIAL PRICE

€ 7,85



H0770 | vaschetta insalatiera | salad bowl
ml 1000 | cm 17x17x5,6 | pz. conf. 24 | c/c 15



SPECIAL PRICE

€ 5,44



H0766 | vaschetta insalatiera | salad bowl
ml 750 | cm 17,3x12,3x5,7 | pz. conf. 24 | c/c 15



SPECIAL PRICE

€ 8,21



H0771 | vaschetta insalatiera | salad bowl
ml 1200 | cm 17x17x6,6 | pz. conf. 24 | c/c 15



SPECIAL PRICE

€ 6,01



H0767 | vaschetta insalatiera | salad bowl
ml 1000 | cm 17,3x12,3x7,5 | pz. conf. 24 | c/c 15



SPECIAL PRICE

€ 8,60



H0772 | vaschetta insalatiera | salad bowl
ml 1400 | cm 17x17x7,5 | pz. conf. 24 | c/c 15

**vaschette
impilabili**
stackable bowls





SPECIAL PRICE

€ 4,73



H0763 | insalatiera | salad bowl |
cm Ø 15x5 - 500 ml | pz. conf. 24 | c/c 15



SPECIAL PRICE

€ 5,29



H0758 | insalatiera | salad bowl |
cm Ø 15x6 - 750 ml | pz. conf. 24 | c/c 15



SPECIAL PRICE

€ 4,82



H0759.V | insalatiera vintage | vintage salad bowl |
cm Ø 15x7,5 - 1000 ml | pz. conf. 24 | c/c 15



SPECIAL PRICE

€ 5,54



H0759 | insalatiera | salad bowl |
cm Ø 15x7,5 - 1000 ml | pz. conf. 24 | c/c 15



SPECIAL PRICE

€ 8,72



Q4017 | coperchio in pla | pla lid |
cm Ø 184 | pz. conf. 24 | c/c 15



SPECIAL PRICE

€ 8,08



H0761 | insalatiera | salad bowl |
cm Ø 184x6,8 - 1300 ml | pz. conf. 24 | c/c 15





SPECIAL PRICE

€ 4,05

H0764 | coperchio insalatiera | lid for salad bowl |
cm Ø 15 | pz. conf. 12 | c/c 15



SPECIAL PRICE

€ 5,29

H0758.Z | insalatiera | salad bowl |
cm Ø 15x6 - 750 ml | pz. conf. 24 | c/c 15



SPECIAL PRICE

€ 3,64

H0760 | coperchio insalatiera | lid for salad bowl |
cm Ø 15 | pz. conf. 24 | c/c 15



SPECIAL PRICE

€ 5,54

H0759.Z | insalatiera | salad bowl |
cm Ø 15x7,5 - 1000 ml | pz. conf. 24 | c/c 15



SPECIAL PRICE

€ 5,02

H0762 | coperchio insalatiera | lid for salad bowl |
cm Ø 184 | pz. conf. 24 | c/c 15



SPECIAL PRICE

€ 8,08

H0761.Z | insalatiera | salad bowl |
cm Ø 184x6,8 -1300 ml | pz. conf. 24 | c/c 15





€ 80,00

H0801 | coppette kraft | kraft paper cup |
cm Ø 7,5x4,5 -90 ml | pz. conf. 1000 (50x20) | c/c 4



€ 99,90

H0802 | coppette kraft | kraft paper cup |
cm Ø 8,5x5 -150 ml | pz. conf. 1000 (50x20) | c/c 4



€ 104,40

H0803 | coppette kraft | kraft paper cup |
cm Ø 9,5x5,5 - 240 ml | pz. conf. 1000 (50x20) | c/c 4



€ 81,80

H0804 | coppette kraft | kraft paper cup |
cm Ø 10,5x6,6 -355 ml | pz. conf. 500 (50x10) | c/c 4



€ 96,85

H0805 | coppette kraft | kraft paper cup |
cm Ø 12x8 -580 ml | pz. conf. 500 (50x10) | c/c 4





€ 9,30

H0720 | contenitore c/coperchio | cup with lid |
cm 9x7,2x8,6 - 350 ml | pz. conf. 25 | c/c 10



€ 10,35

H0721 | contenitore c/coperchio | cup with lid |
cm 9,8x7,5x10 - 470 ml | pz. conf. 25 | c/c 10



€ 12,92

H0722 | contenitore c/coperchio | cup with lid |
cm 11,7x9,2x11 - 740 ml | pz. conf. 25 | c/c 10



€ 15,20

H0723 | contenitore c/coperchio | cup with lid |
cm 11,7x9,2x13,5 - 940 ml | pz. conf. 25 | c/c 10





SPECIAL PRICE

€ 3,14



Q4001 | vaschetta | tray |
cm 9x5,5x3,5 | pz. conf. 50 | c/c 8



SPECIAL PRICE

€ 5,10



Q4011 | insalatiera | salad bowl |
ml 750 | cm Ø 14,8x6 | pz. conf. 24 | c/c 15



SPECIAL PRICE

€ 6,21



Q4003 | vaschetta | tray |
cm 14x8,5x 5,5 | pz. conf. 50 | c/c 8



SPECIAL PRICE

€ 5,35



Q4012 | insalatiera | salad bowl |
ml 1000 | cm Ø 14,8x7,8 | pz. conf. 24 | c/c 15



SPECIAL PRICE

€ 6,72



Q4004 | vaschetta | tray |
cm 17x9,5x5,5 | pz. conf. 50 | c/c 8



SPECIAL PRICE

€ 9,82



Q4019 | hamburger box | hamburger box |
ml 1700 | cm 17x9x84 | pz. conf. 25 | c/c 8



SPECIAL PRICE

€ 5,02



Q4006 | bicchiere per fritti | fries cup |
ml 300 | cm Ø 9x14,8 | pz. conf. 50 | c/c 12

COMPOSTABLE





€ 10,10

H0715 | box con finestra | box with window |
cm 10x10x4 - 400 ml | pz. conf. 25 | c/c 10

PET Pa



€ 12,64

H0716 | box con finestra | box with window |
cm 12x12x4 - 700 ml | pz. conf. 25 | c/c 10

PET Pa



€ 14,14

H0717 | box con finestra | box with window |
cm 14x14x4 - 1000 ml | pz. conf. 25 | c/c 10

PET Pa



€ 17,88

H0718 | box con finestra | box with window |
cm 18x18x4 - 1500 ml | pz. conf. 20 | c/c 10

PET Pa





€ 26,00

T2001 | shopper take away | shopper take away |
cm 27+16x29 | pz. conf. 50 | c/c 5



€ 23,90

T2000 | shopper take away | shopper take away |
cm 22+10x32 | pz. conf. 50 | c/c 5



€ 28,30

T2002 | shopper take away | shopper take away |
cm 32+21x24 | pz. conf. 50 | c/c 4





cartine journal | paper journal 45g/m²



- H6212** | cm 12,5x20 | pz. conf. 500 | c/c 12 € 10,74
- H6215** | cm 15x40 | pz. conf. 500 | c/c 6 € 19,86
- H6220** | cm 20x32,5 | pz. conf. 500 | c/c 6 € 22,50
- H6228** | cm 28x34 | pz. conf. 1000 | c/c 4 € 49,76
- H6231** | cm 31x31 | pz. conf. 1000 | c/c 4 € 51,83
- H6233** | cm 33x32,5 | pz. conf. 500 | c/c 4 € 32,95
- H6238** | cm 31x38 | pz. conf. 1000 | c/c 4 € 46,53
- H6240** | cm 40x32,5 | pz. conf. 500 | c/c 4 € 39,05



cartine vintage | paper vintage 40g/m²



- H6312** | cm 12,5x20 | pz. conf. 500 | c/c 12 € 10,74
- H6315** | cm 15x40 | pz. conf. 500 | c/c 6 € 19,86
- H6320** | cm 20x32,5 | pz. conf. 500 | c/c 6 € 22,50
- H6333** | cm 33x32,5 | pz. conf. 500 | c/c 4 € 32,95
- H6340** | cm 40x32,5 | pz. conf. 500 | c/c 4 € 39,05

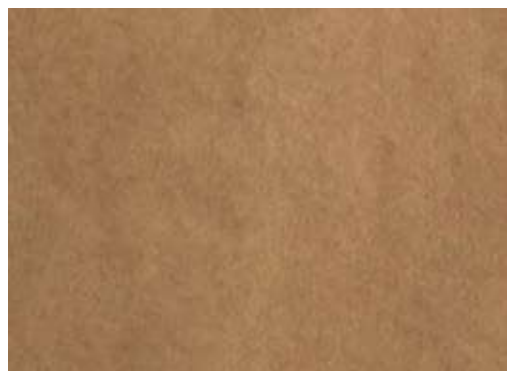

cartine avana | paper avana 40g/m²



- H6112** | cm 12,5x20 | pz. conf. 500 | c/c 12 € 10,26
- H6115** | cm 15x40 | pz. conf. 500 | c/c 6 € 18,15
- H6120** | cm 20x32,5 | pz. conf. 500 | c/c 6 € 20,46
- H6133** | cm 33x32,5 | pz. conf. 500 | c/c 4 € 31,10
- H6140** | cm 40x32,5 | pz. conf. 500 | c/c 4 € 35,42





€ 17,56

H6600 | cono journal | paper cone journal
cm 17x24 | pz. conf. 250 | c/c 8



€ 21,13

H6601 | cono journal | paper cone journal
cm 21x29,5 | pz. conf. 250 | c/c 8



€ 27,30

H6603 | sacchetto journal | paper bag journal
cm 13x14 | pz. conf. 1000 | c/c 6



€ 22,37

H6602 | cono journal | paper cone journal
cm 24x34 | pz. conf. 250 | c/c 4



€ 20,81

H6604 | sacchetto journal | paper bag journal
cm 17x18 | pz. conf. 500 | c/c 8



€ 87,14

H6606 | sacchetto vintage | paper bag vintage |
cm 10+7,5x14 | pz. conf. 2000 | c/c 6



€ 87,14

H6605 | sacchetto vintage | paper bag vintage |
cm 10+4x14 | pz. conf. 2000 | c/c 6



€ 58,65

H6607 | sacchetto vintage | paper bag vintage |
cm 12+9x28 | pz. conf. 1000 | c/c 6





€ 4,60

Q2043.S | cucchiaino in cplA | cplA tea spoon |
cm 10 | pz. conf. 100 | c/c 20



€ 4,60

Q2043.Z | cucchiaino nero | black teaspoon
10cm | pz. conf. 100 | c/c 20



€ 3,50

Q2044.S | cucchiaio bianco | white spoon
12,5cm | pz. conf. 50 | c/c 40



€ 3,50

Q2044.Z | cucchiaio nero | black spoon
12,5cm | pz. conf. 50 | c/c 40



€ 3,25

Q2041.S | forchetta in cplA | cplA fork |
cm 16 | pz. conf. 50 | c/c 20



€ 3,25

Q2041.Z | forchetta nera | black fork
16cm | pz. conf. 50 | c/c 20



€ 3,50

Q2042.S | cucchiaio in cplA | cplA spoon |
cm 16 | pz. conf. 50 | c/c 20



€ 3,50

Q2042.Z | cucchiaio nero | black spoon
16cm | pz. conf. 50 | c/c 20



€ 2,60

Q2040.S | coltello in cplA | cplA knife |
cm 16 | pz. conf. 50 | c/c 20



€ 2,60

Q2040.Z | coltello nero | black knife
16cm | pz. conf. 50 | c/c 20



€ 4,38

Q2045.S | cucchiaino gelato | ice cream spoon
10cm | pz. conf. 100 | c/c 20



€ 74,40

Q2046 | bis posate in cplA | cplA cutlery set |
cm 16 | pz. conf. 250 (50X5) | c/c 6

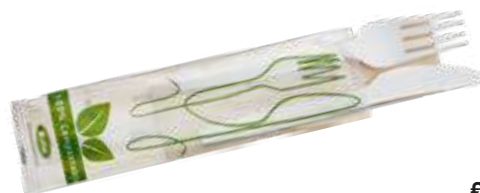

€ 46,95

Q2048.S | bis posate in cplA | cplA cutlery set |
cm 16 | pz. conf. 250 (50X5) | c/c 12

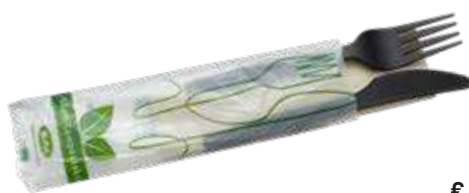

€ 46,95

Q2048.Z | bis posate | set knife, fork, napkin
16cm | pz. conf. 250 (5x50pcs) | c/c 12





COMPOSTABLE



tappo/lid
Ø 5,5

€ 22,00

H0729 | bicchiere carta | paper cup | cm Ø 5,5x5,5 - 75 ml | pz. conf. 1000 (20x50) | c/c 6



tappo/lid
Ø 5,5

€ 22,00

H0729.R | bicchiere coffee | coffee cup | cm Ø 5,5x5,5 - ml 75 | pz. conf. 1000 (50x20) | c/c 6



tappo/lid
Ø 6,2

€ 26,32

H0730.R | bicchiere coffee | coffee cup | cm Ø 6,2x6,3 - ml 115 | pz. conf. 1000 (50x20) | c/c 6



tappo/lid
Ø 6,2

€ 26,32

H0730 | bicchiere carta | paper cup | cm Ø 6,2x6,3 - 115 ml | pz. conf. 1000 (20x50) | c/c 6



tappo/lid
Ø 6,2

€ 26,32

H0730.Y | bicchiere carta | paper cup | cm Ø 6,2x6,3 - 115 ml | pz. conf. 1000 (20x50) | c/c 6



tappo/lid
Ø 7

€ 45,50

H0733.Y | bicchiere carta | paper cup | cm Ø 7x5,8 - 200 ml | pz. conf. 1000 (20x50) | c/c 6



tappo/lid
Ø 8

€ 53,70

H0731 | bicchiere carta | paper cup | cm Ø 8x9 - 240 ml | pz. conf. 1000 (20x50) | c/c 6



tappo/lid
Ø 8

€ 53,70

H0731.Y | bicchiere carta | paper cup | cm Ø 8x9 - 240 ml | pz. conf. 1000 (20x50) | c/c 6



tappo/lid
Ø 8

€ 53,70

H0731.R | bicchiere coffee | coffee cup | cm Ø 8x9 - ml 240 | pz. conf. 1000 (50x20) | c/c 6



tappo/lid
Ø 9

€ 75,38

H0732 | bicchiere carta | paper cup | cm Ø 9x10,2 - 290 ml | pz. conf. 1000 (20x50) | c/c 6



tappo/lid
Ø 9

€ 91,65

H0735.Y | bicchiere carta | paper cup | cm Ø 9x10,8 - 350 ml | pz. conf. 1000 (20x50) | c/c 6



€ 23,34

H0749 | tappo ps nero | black ps lid | cm Ø 5,5 | pz. conf. 1000 (50x20) | c/c 6



€ 30,82

H0740 | tappo nero in ps | black ps lid | cm Ø 6,2 | pz. conf. 1000 (20x50) | c/c 6 PS



€ 40,35

H0743 | tappo nero in ps | black ps lid | cm Ø 7 | pz. conf. 1000 (20x50) | c/c 6 PS



€ 43,16

H0741 | tappo nero in ps | black ps lid | cm Ø 8 | pz. conf. 1000 (20x50) | c/c 6 PS



€ 64,50

H0742 | tappo nero in ps | black ps lid | cm Ø 9 | pz. conf. 1000 (20x50) | c/c 6 PS



€ 9,49

H0737 | portabicchiere da 2 | 2-paper cup holder | cm 17x11,5x3,5 | pz. conf. 50 | c/c 8 Pa



€ 14,05

H0738 | portabicchiere da 4 | 4-paper cup holder | cm 29x17,5x3,5 | pz. conf. 50 | c/c 6 Pa





tappo/lid
Ø 9

€ 110,46

H0748.T | bicchiere Sunset |
Sunset cup | cm Ø 9x13.3 - ml 470
pz. conf. 1000 (50x20) | c/c 6



tappo/lid
Ø 9

€ 110,46

H0748.Z | bicchiere Night | Night cup
cm Ø 9x13.3 - ml 470 |
pz. conf. 1000 (50x20) | c/c 6



tappo/lid
Ø 9

€ 110,46

H0748.G | bicchiere Summer |
Summer cup | cm Ø 9x13.3 - ml 470
pz. conf. 1000 (50x20) | c/c 6



tappo/lid
Ø 9



€ 110,46

H0748.K | bicchiere Havana
Havana cup | cm Ø 9x13.3 - ml 470
pz. conf. 1000 (50x20) | c/c 6







€ 3,30

Q4030 | bicchiere pla | pla glass | 
ml. 160/200 | pz. conf. 50 | c/c 30 





€ 6,09

Q4031 | bicchiere pla | pla glass | 
ml. 200/300 | pz. conf. 50 | c/c 20 





€ 7,63

Q4032 | bicchiere pla | pla glass | 
ml. 300/400 | pz. conf. 50 | c/c 20 



€ 9,55

Q4033 | bicchiere pla | pla glass | 
ml. 400/565 | pz. conf. 50 | c/c 16 





CEL
€ 8,09

H8012.2 | sottobicchiere
bianco | white airlaid coaster |
cm Ø 9 | pz. conf. 250 | c/c 16



CEL
€ 9,85

H8014.T2 | sottobicchiere
creta | clay coaster | cm Ø 9 |
pz. conf. 250 | c/c 16



CEL
€ 9,85

H8014.N2 | sottobicchiere
bordeaux | burgundy coaster |
cm Ø 9 | pz. conf. 250 | c/c 16



CEL
€ 9,85

H8014.Z2 | sottobicchiere
nero | black airlaid coaster |
cm Ø 9 | pz. conf. 250 | c/c 16

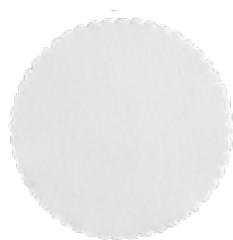

CEL
€ 10,51

H8011.2 | sottocoppa bianca
| white airlaid coaster | cm Ø
11,5 | pz. conf. 250 | c/c 18



CEL
€ 12,38

H8013.T2 | sottocoppa creta
| clay coaster | cm Ø 11,5 | pz.
conf. 250 | c/c 18



CEL
€ 12,38

H8013.N2 | sottocoppa bor-
deaux | burgundy coaster | cm
Ø 11,5 | pz. conf. 250 | c/c 18



CEL
€ 12,38

H8013.Z2 | sottocoppa nero |
black coaster | cm Ø 11,5 | pz.
conf. 250 | c/c 18



CEL
€ 11,00

H8014 | sottobicchiere colori
assortiti | mixed coasters | cm
Ø 9 | pz. conf. 250 | c/c 16



CEL
€ 13,59

H8013 | sottocoppa colorate
| mixed coasters | cm Ø 11,5 |
pz. conf. 250 | c/c 18



CEL
€ 9,85

H8017 | sottobicchiere cuore
| heart coaster | cm Ø 9 | pz.
conf. 250 | c/c 16



CEL
€ 25,91

H9006.N | sottopiatto borde-
aux | burgundy dish placemat |
cm Ø 21 | pz. conf. 200 | c/c 8



CEL
€ 18,59

H9005 | sottopiatto bianco |
white dish placemat | cm Ø 21
| pz. conf. 200 | c/c 8



CEL
€ 20,79

H9004.N | sottopiatto borde-
aux | burgundy dish placemat |
cm Ø 18 | pz. conf. 200 | c/c 8



CEL
€ 15,46

H9003 | sottopiatto bianco |
white dish placemat | cm Ø 18
| pz. conf. 200 | c/c 8



CEL
P

€ 73,80

H8007.F | sottobicchieri ovatta |
paper coaster | cm Ø 8,5 | pz. conf.
1000 | c/c 10



CEL

€ 42,24

H8016 | sottobicchiere ovatta |
paper coaster | cm Ø 10 | pz. conf.
500 | c/c 10



!
CEL
P

€ 39,60

H9002.Y | sottopiatto ovatta | paper
| cm Ø 20 | pz. conf. 150 | c/c 10



CEL

€ 7,87

H9007.S | sottopiatto intreccio
grigio | grey placemat | cm Ø 32 |





Pizzo Regal tondo 40 gr/mq

cod.	0 est.	0 int.	pz.	c/c	€
H3110	10	5,3	250	20	1,72
H3112	12	6	250	8	2,18
H3114	14	7,3	250	8	2,45
H3116	16	8	250	8	3,09
H3118	18	10,3	250	8	3,77
H3120	20	11	250	8	4,57
H3124	24	13,8	250	8	5,90
H3128	28	17,9	250	8	8,62
H3130	30	19,5	250	8	10,02
H3132	32	184	250	4	10,89
H3134	34	19,8	250	4	12,15
H3136	36	22,5	250	4	14,37

Smaltato tondo 60 gr/mq

cod.	0 est.	0 int.	pz.	c/c	€
H1414	14	7,3	100	20	1,70
H1417	17	9	100	20	2,21
H1420	20	11	100	20	3,28
H1423	23	12,8	100	20	3,71
H1425	25	15	100	20	4,00
H1428	28	17,9	100	20	5,83
H1430	30	19,5	100	20	6,66
H1432	32	184	100	20	6,90
H1436	36	22,5	100	20	8,89
H1438	38	254	100	20	9,30

Smaltato rettangolare 60 gr/mq

cod.	est.	int.	pz.	c/c	€
H1520	20x30	10x20	100	20	4,87
H1525	25x35	15x244	100	20	6,00
H1530	30x40	18x28,5	100	20	8,68
H1535	35x45	22,5x32	100	10	12,48
H1540	40x50	26x36,5	100	10	15,85





Sottofritto ovale 40 gr/mq

cod.	dim.	pz.	c/c	€
H2216	16x24	500	10	18,24
H2218	18x27	500	10	20,62
H2221	21x32	500	10	28,30
H2222	22x34	500	10	31,51
H2226	26x40	500	5	41,25
H2229	28x46	500	5	52,27
H2232	32x50	500	5	58,79



Sottofritto tondo 40 gr/mq

cod.	Ø	pz.	c/c	€
H2115	15	500	10	12,45
H2118	18	500	10	16,58
H2121	21	500	10	19,52
H2123	23	500	10	24,55
H2125	25	500	10	26,10
H2128	28	500	10	26,75
H2130	30	500	10	35,77
H2132	32	500	10	44,34



Regal rettangolare 40 gr/mq

cod.	est.	int.	pz.	c/c	€
H3220	20x30	10x20	250	8	6,72
H3225	25x35	15x24,4	250	8	9,33
H3230	30x40	18x28,5	250	4	12,95
H3235	35x45	22,5x32	250	4	16,12
H3240	40x50	26x36,5	250	4	20,14



PAPER DOYLES



€ 115,90

T6010.P | buste portatovagliolo | serviette holder |
cm 14x28 | pz. conf. 500 | c/c 6



€ 39,66

T2153.P | tovagliette Venice | placemat Venice |
cm 30x40 | pz. conf. 500 | c/c 3



€ 25,50

T6000.G | collarino per bottiglie | bottle collar |
cm 11,5x7 | pz. conf. 250 | c/c 20



€ 28,45

T2152 | tovagliette Dallas | placemat Dallas |
cm 30x40 | pz. conf. 500 | c/c 4



€ 25,50

T6002 | collarino per bottiglie | bottle collar |
cm 11,5x7 | pz. conf. 250 | c/c 20



€ 30,36

T2153.0 | tovagliette Venice | placemat Venice |
cm 30x40 | pz. conf. 500 | c/c 3



€ 46,97

T2153.Z | tovagliette Venice | placemat Venice |
cm 30x40 | pz. conf. 500 | c/c 3





€ 51,70

T2102 | portaposate Dallas | cutlery holder Dallas |
cm tovagl.38x38 2v | pz. conf. 400 | c/c 12

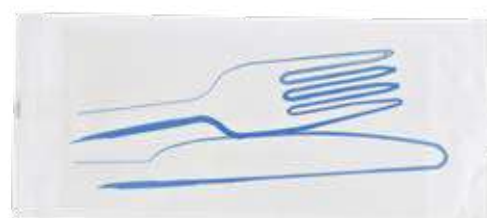

€ 57,37

T2101 | portaposate Dallas | cutlery holder Dallas |
cm tovagl.38x38 2v | pz. conf. 500 | c/c 12



€ 70,13

T2103.Z | portaposate Venice | cutlery holder Venice |
cm tovagl.38x38 2v | pz. conf. 400 | c/c 12



€ 70,13

T2103.P | portaposate Venice | cutlery holder Venice |
cm tovagl.38x38 2v | pz. conf. 400 | c/c 12



€ 70,13

T2103.O | portaposate Venice | cutlery holder Venice |
cm tovagl.38x38 2v | pz. conf. 400 | c/c 12





€ 36,95

T6344 | salvietta Natura | Natura wet wipe | cm 8x6 | pz. conf. 500 | c/c 12



€ 12,80

T6344.CB150 | box salvietta Natura | Natura wet wipe box | cm 8x6 | pz. conf. 150 | c/c 60



€ 35,80

T6342 | salvietta Green Ice | Green Ice wet wipe | cm 8x6 | pz. conf. 500 | c/c 12



€ 7,85

T6335 | salvietta Lemon tree | Lemon tree wet wipe | cm 6x8 | pz. conf. 100 | c/c 60



€ 40,55

T6341.TG | salvietta Metal Blu | Metal Blue wet wipe | cm 9x7 | pz. conf. 500 | c/c 12



€ 40,55

T6700 | cannella e limone | cinnamom and lemon | cm 9x7 | pz. conf. 500 | c/c 12



€ 38,65

T6304.2 | salvietta Sorrento | Sorrento wet wipe | cm 9x7 | pz. conf. 500 | c/c 12



€ 8,65

T6304.C100 | box salvietta Sorrento | Sorrento wet wipe box | cm 9x7 | pz. conf. 100 | c/c 60



€ 63,45

T6345 | salviettone Natura | Natura large wet wipe | cm 14x6 | pz. conf. 500 | c/c 12



€ 61,40

T6343 | salviettone Green Ice | Green Ice large wet wipe | cm 14x6 | pz. conf. 500 | c/c







€ 40,95

T6404 | salvietta alcool mani | sanitizing hand wipe |

cm 9x7 | pz. conf. 400 | c/c 12



€ 33,85

T6402 | salviettone superfici | surface wet wipe |

cm 14x7 | pz. conf. 300 | c/c 12



€ 9,00

T6339 | salvietta Citronella | Citronella wet wipe |

cm 9x7 | pz. conf. 100 | c/c 12



€ 35,05

T6346 | salvietta Mosaico | Mosaico wet wipe |

cm 6x14 | pz. conf. 300 | c/c 12

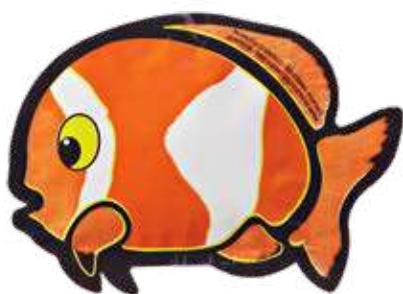

€ 8,65

T6334 | salvietta Pagliaccio | Clownfish wet wipe |

cm 11x8 | pz. conf. 80 | c/c 60



€ 33,95

T6347 | salvietta Mosaico | Mosaico wet wipe |

cm 9x9 | pz. conf. 300 | c/c 12



€ 51,45

T6337 | salviette Pesce blu | Blue fish wet wipe |

cm 11x8 | pz. conf. 500 | c/c 12



€ 8,65

T6337.C80 | box salviette Pesce blu | Blue fish wet wipe box |

cm 11x8 | pz. conf. 80 | c/c 60



€ 51,00

T6309.T2 | salvietta Granchio | Crab wet wipe |

cm 11x8 | pz. conf. 500 | c/c 12

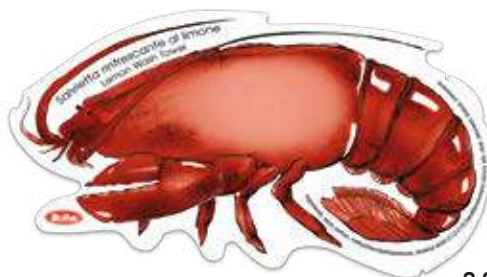

€ 34,40

T6324.T | salviettone Astice | Lobster wet wipe |

cm 15x8 | pz. conf. 250 | c/c 12



Goditi i sapori senza pensieri

Da oggi puoi continuare a gustare i tuoi piatti preferiti senza preoccuparti dello sporco o cattivo odore sulle tue mani, con i guanti per alimenti imbustati a paia

Enjoy the flavours freely

Since today, you can finally enjoy your favourite dishes without concerns about smell & dirt on your hands, thanks by Leone's food contact gloves



€ 7,99

T4025 | guanti monouso per alimenti | disposable food gloves | pz. conf. 250 | c/c 10





€ 10,06

T4003 | bustina carta Elite | paper hat Elite |
cm 28,2x9 | pz. conf. 100 | c/c 10



€ 10,06

T4003.R | bustina carta Natura | paper hat Natura |
cm 28,2x9 | pz. conf. 100 | c/c 10



€ 17,95

T4002 | cappello chef in tnt | tnt chef's hat |
cm 28,5x24 | pz. conf. 25 | c/c 16



€ 17,95

T4002.Z | cappello chef in tnt | tnt black chef's hat |
cm 28,5x24 | pz. conf. 25 | c/c 16



€ 36,90

T6205 | bavaglio astice | lobster bib |
cm 37x40 | pz. conf. 100 | c/c 5



€ 36,90

T6201 | bavaglio fiocco | bow bib |
cm 37x40 | pz. conf. 100 | c/c 5



€ 23,79

T6204 | baby bavaglio | baby bib |
cm 20x24 | pz. conf. 100 | c/c 12



€ 25,60

T6200 | bavaglio bianco | white bib |
cm 37x40 | pz. conf. 100 | c/c 5





NEW
€ 40,56

W2100.M | dispenser sapone mani | hand soap dispenser
ml 380 | pz. conf. 12 | c/c 4



NEW
€ 40,56

W2100.B | dispenser shower shampoo | shower shampoo
dispenser | ml 380 | pz. conf. 12 | c/c 4



NEW
€ 40,56

W2101.M | dispenser sapone mani | hand soap dispenser
ml 380 | pz. conf. 12 | c/c 4



NEW
€ 40,56

W2101.B | dispenser shower shampoo | shower shampoo
dispenser | ml 380 | pz. conf. 12 | c/c 4



chiavetta antifurto
release key

staffa
bracket

adesivo 3M
3M adhesive

NEW
€ 37,90

W2100.S | kit montaggio | assembly kit (**W2100.M / W2100.B**)
set conf. 12 | c/c 4



chiavetta antifurto
release key

staffa
bracket

adesivo 3M
3M adhesive

NEW
€ 37,90

W2101.S | kit montaggio | assembly kit (**W2101.M / W2101.B**)
set conf. 12 | c/c 4





sapone flow pack | soap | gr. 10
W3339 | pz. conf. 150 | c/c 6 € 15,27
W3340 | pz. conf. 600 | c/c 12 € 58,08



sapone flow pack | soap | gr. 14
W3330 | pz. conf. 100 | c/c 6 € 14,01
W3341 | pz. conf. 500 | c/c 12 € 65,55



bustina shower shampoo | ml. 10 |
W3336 | pz. conf. 150 | c/c 6 € 12,50
W3342 | pz. conf. 500 | c/c 12 € 40,10



W3331 | tubo shower shampoo |
 shower shampoo tube | ml. 25 |
 pz. conf. 50 | c/c 6 € 17,66



W3335 | set cucito | sewing kit |
 pz. conf. 50 | c/c 12 € 10,64



W3338 | spugna lucida scarpe |
 shoes sponge | | pz. conf. 50 |
 c/c 6 € 14,42



W3332 | cuffia doccia imbustata |
 sachet shower cap |
 pz. conf. 50 | c/c 6 € 13,18



W3337 | vanity kit | vanity kit |
 pz. conf. 50 | c/c 6 € 14,85



W5200 | strisce garanzia WC |
 WC hygienic strips |
 pz. conf. 1000 | c/c 12 € 26,00



W3334 | set denti | dental kit |
 ml. 7 | pz. conf. 50 | c/c 6 € 35,10



W3333 | set barba | shaving kit |
 ml. 10 | pz. conf. 50 | c/c 6 € 33,20



W5203 | sacchetti igienici |
 hygienic bags | pz. conf. 1000 | c/c 12 € 48,00

NATURA



Shower shampoo
Savon à douche
Gel shampo à douch
Shampoo de ducha
Savon à douchon

Vanity kit
Set de toilette
Set de toilette

Shaving kit
Toilette
Le rasage
Le rasage

Dental kit
Set de dent
Kit dentaire
Kit dental
Sahnpflege-set

Shower cap
Cuffia doccia
Bonnet de douche
Gorra de ducha
Duschhaube

Sewing kit
Set de couture
Set de couture

Shoe sponge
Eponge pour
Sponge pour chaussures
Sponja para calçados
Schuhwischer

Shower soap
Savon à douche
Savon à douche
Savon à douche
Savon à douche

Shower soap
Savon à douche
Savon à douche
Savon à douche
Savon à douche



W1014 - € 58,32

W1015 - € 58,50

sapone flow pack | soap

W1014 | gr. 10 | pz. conf. 600 | c/c 12

W1015 | gr. 14 | pz. conf. 500 | c/c 12



€ 10,76

W1013 | sapone flow pack | flow pack

soap | gr. 10 | pz. conf. 100 | c/c 10



P

€ 22,81

W4603 | set cucito | sewing kit |

pz. conf. 100 | c/c 10



P

€ 24,80

W1011 | sapone astucciato | boxed soap

| gr. 18 | pz. conf. 100 | c/c 10



P

€ 30,46

W4113 | vanity kit | vanity kit |

pz. conf. 100 | c/c 10



P

€ 26,49

W4117 | spugna lucida scarpe | shoes

sponge | | pz. conf. 100 | c/c 10



P

€ 21,21

W3007 | cuffia doccia astucciata | oxed

shower cap | | pz. conf. 100 | c/c 10



P

€ 50,75

W2010 | bustina shower shampoo |

shower shampoo sachet | ml. 10 |

pz. conf. 600 | c/c 12



€ 13,55

W3008 | cuffia doccia imbustata |

shower cap sachet | pz. conf. 100 |

c/c 10



€ 29,15

W2012 | tubo shower shampoo | shower

shampoo tube | ml. 25 | pz. conf. 100 |

c/c 5



€ 37,25

W2015 | tubo crema corpo | body lotion

tube | ml. 25 | pz. conf. 100 | c/c 5



€ 17,55

W1012 | sapone plisse | round soap |

gr. 15 | pz. conf. 100 | c/c 10

ACANTO



P
€ 71,25

W4110 | set denti | dental kit |
ml. 7 | pz. conf. 100 | c/c 10



P
€ 55,35

W4106 | set barba | shaving kit | ml. 10 |
pz. conf. 100 | c/c 10



€ 30,97

W5002 | sacchetti per biancheria |
laundry bag | pz. conf. 100 | c/c 10



€ 10,15

W4230.2CB | sapone flow pack | flow pack soap | gr. 10 | pz. conf. 100 | c/c 10



€ 18,50

W4230.CB | sapone plisse | round soap | gr. 15 | pz. conf. 100 | c/c 10



€ 12,98

W4232.I | cuffia doccia imbustata | sachet shower cap | pz. conf. 100 | c/c 10



€ 12,50

W4240.CB | bustina shower shampoo | shower shampoo sachet | ml. 10 | pz. conf. 150 | c/c 6



€ 11,60

W4232.CB | cuffia doccia astucciata | boxed shower cap | pz. conf. 50 | c/c 10



SPECIAL PRICE

€ 9,30

W4238.CB | spugna lucida scarpe | shoes sponge | | pz. conf. 50 | c/c 10



€ 10,50

W4235.CB | set cucito | sewing kit | pz. conf. 50 | c/c 10



€ 18,20

W4241.CB | Vanity kit | Vanity Kit | pz. conf 50 | c/c 10



€ 17,50

W4233.CB | set barba | shaving set | ml. 10 | pz. conf. 25 | c/c 10



€ 17,50

W4231.CB | tubo bagnodoccia | shower gel tube | ml. 30 | pz. conf. 50 | c/c 10



€ 19,50

W4234.CB | set denti | dental kit | ml. 7 | pz. conf. 25 | c/c 10

LOTHO





imbustato
wrapped

€ 108,90

Q2054 | bicchiere imb. in pla | wrapped pla glass
ml. 200 | pz. conf. 400 | c/c 6



imbustato
wrapped

€ 32,50

H0733.W | bicchiere in carta | paper cup |
ml 200 | pz. conf. 500 (10x50) | c/c 6



imbustato
wrapped

€ 98,50

W4301 | bicchiere imbustato | wrapped glass
ml. 200 | pz. conf. 1000 | c/c 6



€ 7,65

W4102 | non disturbare | do not disturb card
pz. conf. 20 | c/c 25



€ 7,65

W4105 | cambio asciugamani | wash towel advice card
pz. conf. 20 | c/c 25



€ 22,00

T0535 | cestino da camera | round bin |
cm Ø 26x30 | pz. conf. 1 | c/c 12



€ 4,40

T5280.T | cestino porta rifiuti | bin basket |
cm Ø 23x26 | pz. conf. 1 | c/c 24



€ 4,50

T5282.T | cestino porta rifiuti | bin basket |
cm Ø 23x28,5 | pz. conf. 1 | c/c 24



€ 6,50

T5281.T | cestino porta rifiuti | bin basket |
cm Ø 27,5x28,5 | pz. conf. 1 | c/c 24



€ 5,50

T5283.T | cestino porta rifiuti | bin basket |
cm Ø 25x33 | pz. conf. 1 | c/c 24





Pa !

€ 165,00

W4302.Y | copribicchieri |
glass cover | cm Ø 6 |
pz. conf. 1000 | c/c 4



Pa

€ 185,00

W4303.Y | copribicchieri |
glass cover | cm Ø 7 |
pz. conf. 1000 | c/c 4



Pa

€ 23,50

W5201 | strisce garanzia WC |
WC hygienic strips |
pz. conf. 1000 | c/c 12



Pa

€ 48,00

W5101 | sacchetti igienici
carta | hygienic paper bags |
pz. conf. 1000 | c/c 12



€ 15,75

W4401.2 | salvietta lucida
scarpe | shiny shoes tissue |
cm 7x9 | pz. conf. 150 | c/c 5



€ 26,25

W2006 | bustina igiene intima
| intimate hygiene sachet |
ml. 5 | pz. conf. 250 | c/c 5



€ 12,60

W7001 | detersivo per piatti |
dishwashing liquid | ml. 9 |
pz. conf. 150 | c/c 12



!

€ 76,00

W4504.Y | scatola cortesia
Poket | courtesy box Poket |
pz. conf. 100 | c/c 4



€ 32,05

W2003.Q | flacone bagnodoc-
cia | bathgel bottle | ml. 20 |
pz. conf. 100 | c/c 2



€ 32,05

W2003.T | flacone bagnodoc-
cia | bathgel bottle | ml. 20 |
pz. conf. 100 | c/c 2



€ 32,05

W2003.F | flacone bagnodoc-
cia | bathgel bottle | ml. 20 |
pz. conf. 100 | c/c 2



€ 32,05

W2003.Y | flacone bagnodoc-
cia | bathgel bottle | ml. 20 |
pz. conf. 100 | c/c 2



P

€ 37,80

W2007.I | flacone bagnodoc-
cia | bathgel bottle | ml. 30 |
pz. conf. 100 | c/c 3



P

€ 37,80

W2007.T | flacone bagnodoc-
cia | bathgel bottle | ml. 30 |
pz. conf. 100 | c/c 3



P

€ 37,80

W2007.F | flacone bagnodoc-
cia | bathgel bottle | ml. 30 |
pz. conf. 100 | c/c 3



P

€ 41,90

W2008.Y | flacone bagnodoc-
cia | bathgel bottle | ml. 30 |
pz. conf. 100 | c/c 2



! Ac
€ 7,11

T5238 | supporto "U" | display stand "U"
| cm 25x12x3 | pz. conf. 1 | c/c 36



W
€ 5,37

S0070 | vassoio legno | wood tray |
cm 24x9x2,5 | pz. conf. 1 | c/c 48



Ac
€ 5,58

T5237 | vassoio | tray |
cm 20x8x3 | pz. conf. 1 | c/c 48



! Ac
€ 5,50

T5239 | supporto "T" | display stand "T" |
cm 25x17x15 | pz. conf. 1 | c/c 48

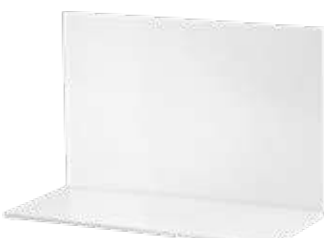

Ac
€ 4,90

T5240 | supporto | plexiglass | acrylic
display stand "I" | cm 25x11,5x16 |
pz. conf. 1 | c/c 32



Ac
€ 6,00

T5225 | vassoio satinato | tray |
cm 15x20x2,7 | pz. conf. 1 | c/c 60



NEW PP
€ 1,17

T5287 | vassoio satinato | satin tray
cm 26,5x8,7x4,5 | pz. conf. 1 | c/c 36



NEW PP
€ 0,77

T5286 | vassoio satinato | satin tray
cm 12,5x8,5x4,5 | pz. conf. 1 | c/c 36



PP
€ 22,18

T0514 | cestino bianco | white basket |
cm 14x11x5 | pz. conf. 10 | c/c 10



NEW PP
€ 1,17

T5285.T | secchiello grigio | grey bucket
ml 450 | pz conf. 1 | c/c 36



NEW PP
€ 1,58

T5284.T | secchiello grigio | grey bucket
ml 1200 | pz conf. 1 | c/c 36



PP
€ 7,41

T0560.Y | cestino bianco | white basket
cm 16x13x6 | pz. conf. 1 | c/c 36



NEW PP
€ 1,17

T5285.A | secchiello bianco | white bucket
ml 450 | pz conf. 1 | c/c 36



NEW PP
€ 1,58

T5284.A | secchiello bianco | white bucket
ml 450 | pz conf. 1 | c/c 36



PP
€ 7,41

T0560.Z | cestino nero | black basket |
cm 16x13x6 | pz. conf. 1 | c/c 36





€ 52,17

W4707 | ciabatte spugna aperte |
opened terry slippers |
pz. conf. 50 paia | c/c 10



€ 52,17

W4702 | ciabatte spugna | terry slippers
pz. conf. 50 paia | c/c 10



€ 83,30

W4709.Z | ciabatte spugna black | black
terry slippers | | pz. conf. 50 paia | c/c 4



€ 71,02

W4706 | ciabatte tnt | tnt slippers |
pz. conf. 100 paia | c/c 12



€ 53,34

W4708 | ciabatte spugna chiuse |
closed terry slippers | | pz. conf. 50 paia
| c/c 10



€ 18,88

W4711 | ciabatta spugna | terry slippers
| pz. conf. 12 paia | c/c 4





€ 14,55

W4331.Z | gruccia nera | black hanger |
pz. conf. 6 | c/c 8



€ 14,19

W4330.Y | gruccia bianca | white hanger |
pz. conf. 6 | c/c 8



€ 14,19

W4330.Z | gruccia nera | black hanger |
pz. conf. 6 | c/c 8



€ 3,78

W4332 | anello antifurto | anti-theft ring
for hanger | | pz. conf. 6 | c/c 50



€ 8,87

T5246 | campanello reception | reception
call bell | cm Ø 10 | pz. conf. 1 | c/c 6



€ 28,99

P5100.Z | bollitore elettrico | black kettle
| cm Ø 16x 23 - 1,7 | | pz. conf. 1 | c/c 4



- Potenza/ Power 1500 W
- Voltaggio/Voltage 220-240 V
- Design ergonomico con luce rossa per accensione/
Ergonomic design with red light when the kettle is working
- Interno in acciaio inox /stainless steel inner
- Garanzia 1 anno / Warranty 1 year
- Conforme alle norme CE/ Complies with CE



€ 115,79

W5103 | reggivaligia in legno | wooden support for suitcase | cm 65x36x51 | pz. conf. 1 | c/c 6



€ 30,64

S5058 | vassoio rettangolare | acacia buffet tray | cm 52x38x5 | pz. conf. 1 | c/c 4



€ 49,79

W5104 | reggivaligia in bamboo | bamboo support for suitcase | cm 65x36x51 | pz. conf. 1 | c/c 4



€ 36,97

S0069.L | vassoio con supporti | tray with holders | cm 58x35x5 | pz. conf. 1 | c/c 4



€ 65,57

W5102 | reggivaligia in acciaio | steel support for suitcase | cm 42x65x72 | pz. conf. 1 | c/c 4



€ 72,90

W5105 | reggivassoio in legno | wood stand tray | cm 42x37x82 | pz. conf. 1 | c/c 3



impilabile
stockable

€ 79,90

W5106 | seggiolone in legno | high baby chair | cm 51x48x74 | pz. conf. 1 | c/c 3



BREAKFAST





Ac
€ 2,75

T5228 | supporto | card stand |
cm 8,5x5 | pz. conf. 1 | c/c 100



Ac
€ 2,00

T5222 | segnaposti | single card stand |
cm 5,5x8,5x2 | pz. conf. 1 | c/c 288



SPECIAL
PRICE

Ac
€ 2,32

T5223 | portabiglietti da visita | card holder
| cm 6,5x10x4,5 | pz. conf. 1 | c/c 96



! Ac
€ 5,33

T5208 | portadepliant | display stand |
cm 22x31 - A4 | pz. conf. 1 | c/c 72



Ac
€ 4,42

T5207 | portadepliant | display stand |
cm 16x18 - A5 | pz. conf. 1 | c/c 48



! Ac
€ 2,83

T5206 | portadepliant | display stand |
cm 10,5x13 | pz. conf. 1 | c/c 24



Ac
€ 10,59

T5229 | supporto dritto | acrylic straight
display - A4 | cm 21x29 - A4 | pz. conf. 1
| c/c 24



Ac
€ 11,74

T5226 | supporto curvato | curved
display | cm 21x29 - A4 | pz. conf. 1 |
c/c 24



Ac
€ 1,13

T5210 | supporto "L" | display stand "L" |
cm 6,25x8,75 | pz. conf. 1 | c/c 480



Ac
€ 5,89

T5230 | supporto dritto | straight display
| cm 14,8x21 - A5 | pz. conf. 1 | c/c 48



Ac
€ 7,10

T5234 | supporto "L" | display stand "L" |
A4 | pz. conf. 1 | c/c 24



Ac
€ 3,31

T5235 | supporto "L" | display stand "L" |
A5 | pz. conf. 1 | c/c 48

PLEXIGLASS



Burgers

Name goes here 00 \$
(Lovers ipsum dolor sit amet)

Name goes here 00 \$
(Lovers ipsum dolor sit amet)

Name goes here 00 \$
(Lovers ipsum dolor sit amet)



Hot Dogs

Name goes here 00 \$
(Lovers ipsum dolor sit amet)

Name goes here 00 \$
(Lovers ipsum dolor sit amet)

Name goes here 00 \$
(Lovers ipsum dolor sit amet)



Grill

Name goes here 00 \$
(Lovers ipsum dolor sit amet)

Name goes here 00 \$
(Lovers ipsum dolor sit amet)

Name goes here 00 \$
(Lovers ipsum dolor sit amet)



Chicken

Name goes here 00 \$
(Lovers ipsum dolor sit amet)

Name goes here 00 \$
(Lovers ipsum dolor sit amet)

Name goes here 00 \$
(Lovers ipsum dolor sit amet)



Fries

Name goes here 00 \$
(Lovers ipsum dolor sit amet)

Name goes here 00 \$
(Lovers ipsum dolor sit amet)

Name goes here 00 \$
(Lovers ipsum dolor sit amet)



Tacos

Name goes here 00 \$
(Lovers ipsum dolor sit amet)

Name goes here 00 \$
(Lovers ipsum dolor sit amet)

Name goes here 00 \$
(Lovers ipsum dolor sit amet)

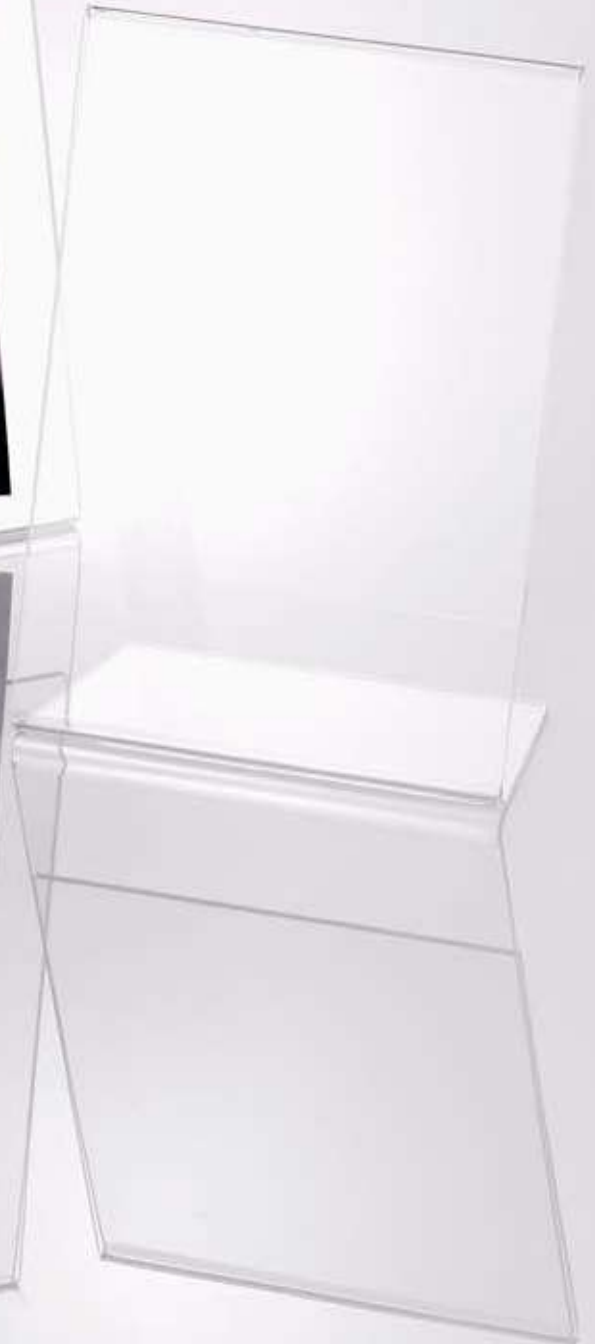



SPECIAL PRICE

€ 2,84

T5274 | porta targa a scatto | snap frame | cm 18x12 - A6 | pz. conf. 1 | c/c 24

! AI



SPECIAL PRICE

€ 7,20

P3004 | secchiello in latta | tin bucket | cm 24,5x17,5x13,3 | pz. conf. 1 | c/c 12

! Fe



SPECIAL PRICE

€ 5,30

T5601 | miscelatore | bar spoon | cm 30 | pz. conf. 1 | c/c 20

! SS



SPECIAL PRICE

€ 2,00

P4003 | spatola a gomito | angled spatula | cm 30 | pz. conf. 1 | c/c 10

! SS



SPECIAL PRICE

€ 20,90

T5606 | shaker c/bicchieri | boston shaker with glass | ml 830 | pz. conf. 1 | c/c 12

! SS



SPECIAL PRICE

€ 1,60

P4006 | spatola dritta | straight spatula | cm 20 | pz. conf. 1 | c/c 10

! SS



SPECIAL PRICE

€ 13,70

T5086 | shaker in acciaio | stainless steel shaker | ml 700 | pz. conf. 1 | c/c 30

! SS



SPECIAL PRICE

€ 2,42

P5110.Z | Borraccia nera | Black bottle | ml 500 | cm Ø 7.3x18.5 | pz. conf. 1 | c/c 12

! AI



SPECIAL PRICE

€ 5,30

T5602 | colino per shaker | bar strainer | pz. conf. 1 | c/c 12

! SS



SPECIAL PRICE

€ 2,40

T8235 | piatto tondo | round plate | cm Ø 16x2 | pz. conf. 1 | c/c 24

! MF



SPECIAL PRICE

€ 7,70

H6012 | cartine bianca | white paper |
cm 12,5x20 | pz. conf. 500 | c/c 12

! Pa



SPECIAL PRICE

€ 10,89

H6015 | cartine bianca | white paper |
cm 15x40 | pz. conf. 500 | c/c 6

! Pa



SPECIAL PRICE

€ 5,20

Q1002 | piatto quadrato | square plate |
cm 14x14x2,5 | pz. conf. 24 | c/c 12

! W



SPECIAL PRICE

€ 9,90

T5301.M | pennarello gesso liquido rosso | red
liquid chalk pen | mm 6 | pz. conf. 12 | c/c 4

!



SPECIAL PRICE

€ 3,90

T5214 | supporto a L | display stand L |
cm 20x25 | pz. conf. 1 | c/c 72

! Ac



SPECIAL PRICE

€ 3,00

T5262 | lavagna con treppiede | tripod blackboard |
cm 9,7x14,8 | pz. conf. 1 | c/c 24

! W



SPECIAL PRICE

€ 3,20

T2213.Y | runner Style | runner Style |
cm 40x120 | pz. conf. 1 | c/c 24

! PP



SPECIAL PRICE

€ 17,70

W3386 | pettine in legno astucciato |
boxed wooden comb | pz. conf. 50 | c/c 5

! W



SPECIAL PRICE

€ 38,00

Q2115 | tappo | lid | cm Ø 9 |
pz. conf. 500 (10x50) | c/c 6

! CEL



SPECIAL PRICE

€ 5,80

W3385 | set cucito (ago, filo, bottoni) | sewing kit
(needle, thread, buttons) | pz. conf. 50 | c/c 10

!



SALVIETTA IMBEVUTA

















- Imballaggio esterno accoppiato: polietilene, alluminio, carta. Salvietta interna in CELLULOSA COMPOSTABILE
- Profumazioni disponibili: Limone, The verde, Citronella/Geranio.
- Impianti stampa € 59,00 per colore
- Scatole standard da 500 pezzi.
- Nella produzione verrà inserito e fatturato il fine lavorazione che potrà variare dal 5 al 10% in più dell'ordine.
- Prezzi su preventivo sulla quadricromia, colori a pantone o per materiali differenti dai nostri standard.
- Supplemento carta avana +5%

CUSTOMIZED REFRESHING TOWEL

- Coupled outer packaging: polythene, aluminium, paper. Internal towel made in COMPOSTABLE CELLULOSE
- Flavourings available: lemon, green tea, lemongrass/geranium.
- Printing plants € 59,00/each color
- Standard cartons made of 500 pieces.
- During the production from 5% to 10% from the ordered quantity come out: this quantity will be invoiced finally.
- Prices for quadrichromy, colors (pantone) or for different materials than our standards: only on demand.
- Brown paper extra charge +5%

RINCE-DOIGTS PERSONNALISÉ

- Emballage extérieur doublé: polythène, aluminium et papier. Rince-doigts à l'intérieur en CELLULOSE COMPOSTABLE
- Aromatisations disponibles: citron, the vert, citronnelle/géranium.
- Installation d'impression: € 59,00/par couleur
- Carton standard de 500 pièces.
- Pendant la production, une différence du 5% au 10% sur la quantité commandées peut sortir et sera facturée.
- Prix sur la quadrichromie, couleurs à pantone et matières premières différentes de nos standards.
- Havane papier supplément +5%

		COD.	esterno	salvietta	PCS	1 COL.	2 COL.	3 COL.
		500 PEZZI						
	T6305 	60x80	19x10,5	10000	38,45	44,99	48,13	
				20000	33,53	37,90	38,44	
				50000	29,74	30,98	31,53	
				100000	27,31	27,85	28,23	
	T6306 	70x90	19x12,5	10000	41,10	49,48	50,78	
				20000	36,24	39,42	41,10	
				50000	30,28	31,74	32,34	
				100000	29,63	30,18	30,66	
	T6308 	70x106	19x14	10000	43,91	51,38	53,48	
				20000	38,99	42,23	43,80	
				50000	33,09	34,23	34,88	
				100000	32,23	32,77	33,09	
	T6316 	60x140	19x19	10000	51,48	58,35	61,59	
				20000	46,77	50,35	51,91	
				50000	40,45	41,58	42,23	
				100000	39,58	40,13	40,45	
	T6323 	70x140	19x19	10000	52,34	59,27	62,51	
				20000	48,02	51,26	52,78	
				50000	40,99	42,56	43,10	
				100000	40,78	40,99	40,88	
	T6306.TQ 	90x90	19x12,5	10000	46,99	52,78	56,72	
				20000	41,53	44,77	46,45	
				50000	40,45	37,31	38,55	
				100000	34,12	34,66	35,31	
	T6303S 	110x70	19x12,5	10000	57,80	62,51	66,50	
				20000	52,24	55,92	57,92	
				50000	39,91	41,64	42,34	
				100000	39,58	40,13	41,58	
	T6309S 	110x70	19x12,5	10000	57,80	62,51	66,50	
				20000	52,24	55,92	57,92	
				50000	39,91	41,64	42,34	
				100000	39,58	40,13	41,58	

PERSONALIZZAZIONE ARTICOLI VARI

1. Inviare il vostro ordine indicando l'articolo che desiderate personalizzare e il colore di stampa, allegando il vostro logo in originale (formato PDF HD o vettoriale).
2. Effettuata l'elaborazione del logo verrà inviata una bozza
3. Completato il controllo della bozza, inviare mail di conferma
 - TEMPI DI CONSEGNA possono variare dai 30/60 giorni in base all'articolo e al periodo dell'anno.
 - COSTO DELL'IMPIANTO STAMPA € 59,00
Verrà addebitato solo al primo ordine o ad ogni modifica dei dati, o del tipo di impianto (A, B vedi listino seguente).



cod.	articolo	min. pz.	impianto	€ conf.
W1011S	sapone astucciato 18gr			
Acanto	boxed soap 18gr	1000	A	280,00
W2010S	bustina doccia shampoo 10ml			
Acanto	bath gel & shampoo 10ml	1200	A	150,00
W3007S	cuffia doccia astucciata			
Acanto	boxed shower cap	500	A	130,00
W4106S	set barba astucciato			
Acanto	boxed shaving kit	200	A	118,00
W4110S	set spazzolino dentifricio			
Acanto	toothbrush & paste set	200	A	154,00
W4113S	cotton fioc 4pcs			
Acanto	cotton bud 4pcs	200	A	45,00
W4117S	spugna lucidascarpe			
Acanto	shoes sponge	200	A	65,00
W4603S	set cucito			
Acanto	sewing kit	200	A	59,00
W2007SI	doccia shampoo giallo 30ml			
Tulip	yellow shower shampoo 30ml	500	A	246,00
W2007SF	doccia shampoo azzurro 30ml			
Tulip	blue shower shampoo 30ml	500	A	246,00
W2007ST	doccia shampoo traspar. 30ml			
Tulip	transp. shower shampoo 30ml	500	A	246,00
W2008SY	doccia shampoo bianco 30ml			
Dalia	white shower shampoo 30ml	500	A	259,00
L1S1	stuzzicadenti 2 punte imbustati			
	wrapped toothpicks	10000	B	90,00
L1S2	stuzzicadenti 2 punte imbustati			
	wrapped toothpicks	20000	B	165,00
T6303S	salvietta pesce blu al limone			
	blu fish lemon wet wipe	1000	A	130,00
T6304S	salvietta al limone			
	lemon wet wipe	1000	A	118,00
T6309S	salvietta granchio al limone			
	crab lemon wet wipe	1000	A	129,00
T6324S	salvietta astice al limone			
	lobster lemon wet wipe	1000	A	173,00

Per sottobicchieri e infrapiatti in ovatta
minimo d'ordine 5000 pezzi.

Richiedere preventivo a:

info@leonedecorazioni.com

Art.	pag.		Art.	pag.		Art.	pag.
B051	229	H0704	258	H0748.G	276	H1436	280
B1S	229	H0705	256	H0748.K	276	H1438	280
B2	223	H0706	256	H0748.T	276	H1520	280
B36.1	229	H0707	254	H0748.Z	276	H1525	280
B36L.1	229	H0708	254	H0749	274	H1530	280
B36S	229	H0708.V	254	H0751	258	H1535	280
B940.S	221	H0710	256	H0752	258	H1540	280
B941.S	221	H0711	254	H0753	258	H1611	227
B943	221	H0712	254	H0754	258	H2115	281
B946.S	221	H0712.V	254	H0755	258	H2118	281
B947.S	221	H0713	258	H0756	258	H2121	281
B948.S	221	H0714	258	H0757	256	H2123	281
B949.S	221	H0715	268	H0758	262	H2125	281
B950	221	H0716	268	H0758.Z	263	H2128	281
B951	221	H0717	268	H0759	262	H2130	281
B952	221	H0718	268	H0759.V	262	H2132	281
BI0913	220	H0719	254	H0759.Z	263	H2216	281
BI0920.Y	220	H0720	265	H0760	263	H2218	281
BI0920.Z	220	H0721	265	H0761	262	H2221	281
BI0921.Z	220	H0722	265	H0761.Z	263	H2222	281
BI0922.Y	220	H0723	265	H0762	263	H2226	281
BI0922.Z	220	H0724	256	H0763	262	H2229	281
BI0923	220	H0725	256	H0764	263	H2232	281
BI0929	220	H0726	256	H0765	260	H3110	280
C0013	212	H0727	254	H0766	260	H3112	280
C0020.O	212	H0729	274	H0767	260	H3114	280
C0020.Y	212	H0729.R	274	H0768	260	H3116	280
C0109.A	212	H0730	274	H0769	260	H3118	280
C0109.F	212	H0730.R	274	H0770	260	H3120	280
C0112.O	212	H0730.Y	274	H0771	260	H3124	280
C0112.Y	212	H0731	274	H0772	260	H3128	280
C0261	212	H0731.R	274	H0773	260	H3130	280
G2763	176	H0731.Y	274	H0801	264	H3132	280
G2763PP	176	H0732	274	H0802	264	H3134	280
G2764	176	H0733.W	298	H0803	264	H3136	280
G2764PP	176	H0733.Y	274	H0804	264	H3220	281
G5000	176	H0735.Y	274	H0805	264	H3225	281
G5001	176	H0737	275	H1414	280	H3230	281
G5002	176	H0738	275	H1417	280	H3235	281
G5021	176	H0740	275	H1420	280	H3240	281
G5023	176	H0741	275	H1423	280	H6012	308
G5033	176	H0742	275	H1425	280	H6015	308
H0701	256	H0743	275	H1428	280	H6112	270
H0702	256	H0746.V	254	H1430	280	H6115	270
H0703	258	H0747.V	254	H1432	280	H6120	270
						H6133	270
						H6140	270
						H6212	270
						H6215	270
						H6220	270
						H6228	270
						H6231	270
						H6233	270
						H6238	270
						H6240	270
						H6312	270
						H6315	270
						H6320	270
						H6333	270
						H6340	270
						H6600	271
						H6601	271
						H6602	271
						H6603	271
						H6604	271
						H6605	271
						H6606	271
						H6607	271
						H8007.F	279
						H8011.2	278
						H8012.2	278
						H8013	278
						H8013.N2	278
						H8013.T2	278
						H8013.Z2	278
						H8014	278
						H8014.N2	278
						H8014.T2	278
						H8014.Z2	278
						H8016	279
						H8017	278
						H9002.Y	279
						H9003	278
						H9004.N	278
						H9005	278
						H9006.N	278
						H9007.S	279
						L1	228
						L101	228
						L102	228

Art.	pag.		Art.	pag.		Art.	pag.		
L103	228	P2136	164	Q1021	230	Q2041.Z	272	Q2091	246
L2	228	P2137	164	Q1022	230	Q2042.S	272	Q2092	246
P1004	160	P2138	164	Q1023	230	Q2042.Z	272	Q2095	248
P1005	172	P2139	170	Q1025	230	Q2043.S	272	Q2096	248
P1006	172	P2140	170	Q1027	230	Q2043.Z	272	Q2099	244
P1007	160	P2141	170	Q1028	230	Q2044.S	272	Q2100	244
P1007.T	160	P2142	163	Q1030	232	Q2044.Z	272	Q2101	244
P1008	160	P2143	170	Q1031	232	Q2045.S	272	Q2102	244
P1009	160	P2144	170	Q1032	232	Q2046	272	Q2103	244
P1010	160	P2145	170	Q1033	232	Q2048.S	272	Q2104	246
P1011	172	P3000	173	Q1040	230	Q2048.Z	272	Q2105	246
P2000	161	P3004	308	Q1041	230	Q2054	298	Q2106	246
P2001	161	P4000	214	Q1042	230	Q2057	249	Q2107	244
P2002	161	P4001	214	Q2000	250	Q2058	249	Q2108	244
P2003	161	P4002	214	Q2001	250	Q2059	249	Q2109	244
P2004	161	P4003	308	Q2002	250	Q2060	240	Q2110	244
P2100	168	P4004	214	Q2003	250	Q2060.C	240	Q2111	242
P2101	168	P4005	214	Q2004	248	Q2061	240	Q2112	242
P2102	171	P4006	308	Q2005	248	Q2062	240	Q2113	242
P2103	171	P4007	186	Q2006	250	Q2063	240	Q2115	308
P2104	168	P4008	186	Q2007	250	Q2064	249	Q2116	240
P2105	168	P5000	152	Q2008	248	Q2065	240	Q2117	243
P2106	171	P5001	152	Q2009	248	Q2066	246	Q2118	243
P2107	171	P5002	152	Q2010	238	Q2066.C	246/248	Q2119	243
P2108	171	P5003	152	Q2011	238	Q2067	246	Q2120	243
P2109	162	P5004	152	Q2012	238	Q2068	246	Q2121	243
P2110	162	P5006	152	Q2013	238	Q2069	240	Q2122	243
P2111	162	P5007	152	Q2014	239	Q2070	240	Q2123	243
P2112	162	P5100.Z	303	Q2015	239	Q2071	241	Q2124	243
P2113	162	P5102	154	Q2016	239	Q2072	239	Q2125	240
P2114	162	P5103	154	Q2017	238	Q2073	248	Q4001	266
P2119	168	P5110.Z	308	Q2018	238	Q2074	248	Q4003	266
P2120	168	P5112	155	Q2019	238	Q2075	248	Q4004	266
P2121	168	P5114.Y	155	Q2020	238	Q2076	248	Q4006	266
P2122	168	P5114.Z	155	Q2021	238	Q2077	240	Q4011	266
P2123	167	Q1001	234	Q2022	242	Q2078	240	Q4012	266
P2124	167	Q1002	308	Q2023	242	Q2079	241	Q4017	262
P2125	167	Q1007	234	Q2024	246	Q2080	241	Q4019	266
P2126	167	Q1011	232	Q2025	238	Q2081	241	Q4030	277
P2127	167	Q1012	232	Q2030	249	Q2082	241	Q4031	277
P2128	167	Q1013	232	Q2031	249	Q2083	244	Q4032	277
P2129	167	Q1014	232	Q2034	250	Q2084	244	Q4033	277
P2130	167	Q1015	232	Q2035	250	Q2085	244	Q5000.K	252
P2131	164	Q1016	232	Q2036	250	Q2086	241	Q5001.K	252
P2132	164	Q1017	232	Q2037	250	Q2087	239	Q5015.K	252
P2133	164	Q1018	232	Q2040.S	272	Q2088	238	Q5030.K	252
P2134	164	Q1019	230	Q2040.Z	272	Q2089	238	Q5100.K	253
P2135	164	Q1020	230	Q2041.S	272	Q2090	248	Q5101.K	253

Art.	pag.		Art.	pag.		Art.	pag.
Q5110	253	S0025	224	S0060.L	131	S0108	122
Q5115.K	253	S0026	224	S0060.S	131	S0109	140
Q5130.K	253	S0027	224	S0060.XL	131	S0109.R	140
Q6000	237	S0028	225	S0061	126	S0110	224
Q6001	237	S0029.Z	222	S0061.Z	126	S0110.R	224
Q6002	237	S0030	216	S0062	126	S0111	120
Q6003	237	S0030.Z	216	S0062.Z	126	S0112	120
Q6004	236	S0031	216	S0063	126	S0113	120
Q6005	236	S0031.Z	216	S0063.Z	126	S0118	126
Q6006	236	S0032	216	S0069.L	304	S0119	126
Q6007	237	S0032.Z	216	S0070	300	S0121	120
Q6008	237	S0033	216	S0071	202	S0122	120
Q6009	236	S0033.Z	216	S0072	118	S0123	125
Q6010	236	S0034	216	S0073	118	S0124	125
Q6011	236	S0034.Z	216	S0074	118	S0125	125
Q6012	235	S0035.F	227	S0075.Z	219	S0126	118
Q6013	235	S0035.K	227	S0076	206	S0127	128
Q6014	235	S0035.S	227	S0077	226	S0128	133
Q6015	235	S0037	226	S0077.Z	226	S0128.Z	133
Q6016	235	S0037.P	226	S0078	128/188	S0130	133
Q6017	235	S0037.T	226	S0079	128/189	S0131	140
S0005	228	S0037.Z	226	S0081	120	S0132	140
S0006	228	S0039	225	S0082	120	S0133	134
S0007.2	223	S0041	218	S0083	119	S0134	134
S0007S	223	S0041.S	218	S0085	130	S0135	134
S0008	222	S0042	218	S0085.Z	130	S0136	134
S0009.2	225	S0042.S	218	S0086	130	S0201	156
S0010.2	223	S0043	218	S0086.Z	130	S0201.P	156
S0010S	223	S0043.S	218	S0087	136	S0202	156
S0011.2	222	S0044	219	S0088	136	S0202.P	156
S0011.Z	222	S0044.S	219	S0089	128	S0203	156
S0012.2	222	S0045	219	S0090	126	S0203.P	156
S0012.Z	222	S0045.S	219	S0090.Z	126	S0204	156
S0014	223	S0046	219	S0091	118	S0204.P	156
S0014S	223	S0046.S	219	S0092	118	S0205	156
S0015	222	S0047	219	S0094	120	S0205.P	156
S0015.Z	222	S0047.S	219	S0095	131	S0206	156
S0016	223	S0048	219	S0096	131	S0210.P	156
S0016.M	223	S0048.S	219	S0097	133	S0300	207
S0016.Z	223	S0049.S	218	S0100	122/138	S0302	207
S0017	223	S0050.S	218	S0101	138	S0303	207
S0017S	223	S0051.S	219	S0102	122	S0304	207
S0018	223	S0052.S	218	S0103	122	S0305	222
S0019	223	S0053.S	218	S0104	128	S0306	222
S0020	230	S0054.S	218	S0105	130	S1000	136
S0021	223	S0058	234	S0105.Z	130	S1001	136
S0022	225	S0059	234	S0106	226	S1003	138
S0024	223	S0060	131	S0107	226	S1004	138
						S1005	122
						S1006	140
						S1007	140
						S2001	224
						S2003	224
						S2005	224
						S2006	224
						S2007	224
						S2008	224
						S2009	224
						S4000	119
						S4001	128
						S4002	128
						S4003	128
						S4004	128
						S4005	122
						S4006	128
						S4007	124
						S4008	124
						S4009	125
						S4010	125
						S4011	124
						S4012	124
						S4013	124
						S4014	124
						S4015	119
						S4016	119
						S4017	119
						S4100	116
						S4101	116
						S4102	116
						S4103	116
						S4104	117
						S4105	117
						S4106	117
						S4107	117
						S4108	116
						S4109	116
						S4110	116
						S4111	116
						S4112	134
						S4114	119
						S4115	117
						S5000	102
						S5000.R	102
						S5000.T	102
						S5001	102
						S5001.R	102

Art.	pag.		Art.	pag.		Art.	pag.		
S5001.T	102	S5055	94	T0006.Z	150	T0561.R	148	T2103.Z	283
S5002	102	S5056	94	T0501	151	T0561.T	148	T2152	282
S5002.R	102	S5057	94	T0505	151	T0561.Y	148	T2153.0	282
S5002.T	102	S5058	304	T0508	187	T0561.Z	148	T2153.P	282
S5003	98	S5059	110	T0509	187	T0562	146	T2153.Z	282
S5004	98	S5060	110	T0514	300	T0562.Z	146	T2200.P12	202
S5005	98	S5061	110	T0520.Y	151	T0563	146	T2200.U12	202
S5006	98	S5062	112	T0520.Z	151	T0563.Z	146	T2203.P12	203
S5009	109	S5063	112	T0525	144	T0564	146	T2203.R12	203
S5010	109	S5064	108	T0527	144	T0564.Z	146	T2203.T12	203
S5011	109	S5065	108	T0528	145	T0565	146	T2204.P	203
S5012	109	S5066	108	T0529.A	151	T0565.Z	146	T2204.R	203
S5013	112	S5067	108	T0529.P	151	T0574	95	T2204.T	203
S5014	110	S5068	92	T0529.T	151	T0575.L	95	T2213.Y	309
S5015	110	S5069	92	T0529.Y	151	T0575.M	95	T2214.P12	202
S5016	112	S5070	92	T0529.Z	151	T0576.L	95	T2214.R12	202
S5017	109	S5071	102	T0530.R	151	T0576.M	95	T2214.Z12	202
S5018	109	S5072	102	T0531.R	151	T0576.S	95	T2217	202
S5021	98	S5073	51/102	T0532.R	151	T0577	94	T2218	200
S5022	98	S5080	114	T0533.R	151	T0578	64	T2221.P4	202
S5023	98	S5081	114	T0534	144	T0580.Y	60	T2221.Z4	202
S5024	98	S5082	114	T0534.A	144	T0580.Z	60	T2224.R4	200
S5025	98	S5083	114	T0535	298	T0581.Y	60	T2224.U4	200
S5026	96	S5100	104	T0536	145	T0581.Z	60	T2224.Z4	200
S5027	110	S5101	104	T0537	143	T0582.Y	60	T2225.R4	200
S5028	110	S5102	100	T0540	145	T0582.Z	60	T2225.T4	200
S5029	110	S5103	106	T0544	144	T0583.Y	60	T2225.U4	200
S5030	112	S5104	106	T0545	144	T0583.Z	60	T2226.B12	200
S5031	96	S6000	90	T0546	145	T0584.Y	60	T2226.T12	200
S5032	110	S6001	90	T0547	142	T0584.Z	60	T2226.Z12	200
S5033	110	S6002	90	T0547.Y	142	T0585.Y	60	T3010	199
S5034	108	S6003	90	T0548	142	T0585.Z	60	T3011	199
S5035	108	S6004	91	T0548.Y	142	T0586.Y	60	T3012	199
S5040	97	S6005	91	T0549	143	T0586.Z	60	T3013	199
S5041	97	S6006	91	T0549.Y	143	T0587.Y	60	T3015	199
S5042	97	S6007	91	T0550	106/138/142	T0587.Z	60	T3017	96
S5043	97	SB1M.2	229	T0551	106/138/142	T1005.K	189	T3018	196
S5044	98	SK1	228	T0552	143	T1005.Z	189	T3019	196
S5045	106	SP1	225	T0553	51	T1007	189	T3022	196
S5046	106	SP2S	225	T0554	143	T1008	189	T3023	196
S5047	104	SP3S	225	T0558.R	148	T1009	189	T3024	196
S5048	104	SP4S	225	T0558.T	148	T2000	269	T3025	196
S5049	92	SP5S	225	T0558.Z	148	T2001	269	T3026	196
S5050	92	T0003.R	150	T0559.R	148	T2002	269	T3027	132/196
S5051	92	T0003.Z	150	T0559.T	148	T2101	283	T3028	132/196
S5052	92	T0004.Z	150	T0559.Z	148	T2102	283	T3030	132
S5053	96	T0005.Z	150	T0560.Y	300	T2103.0	283	T3031	132
S5054	92	T0006.R	150	T0560.Z	300	T2103.P	283	T3032	132

Art.	pag.		Art.	pag.		Art.	pag.
T3033	132	T5018	190	T5099	191	T5285.A	188/300
T3200	194	T5019	190	T5101	191	T5285.T	188/300
T3201	194	T5020	185	T5102	191	T5286	188/300
T3202	194	T5021	185	T5103	191	T5287	188/300
T3203	194	T5022	185	T5104	191	T5300	207
T3204	194	T5023	185	T5106	106/138	T5301.M	309
T3205	194	T5024	104/136/140	T5121	191	T5302	207
T3206	194	T5026	188	T5206	306	T5401	186
T3207	194	T5027	188	T5207	306	T5409	188
T3208	194	T5040	184	T5208	306	T5416	206
T3209	194	T5041.Z	191	T5210	306	T5417	206
T4002	289	T5042	184	T5214	309	T5420	158
T4002.Z	289	T5043	184	T5222	306	T5422	158
T4003	289	T5044	184	T5223	306	T5423	158
T4003.R	289	T5045	185	T5225	300	T5424	158
T4005	214	T5046	185	T5226	306	T5426	158
T4006	214	T5048	185	T5228	206/306	T5431.M	158
T4007	214	T5051	182	T5229	306	T5431.O	158
T4025	288	T5052.C	104/136	T5230	306	T5431.T	158
T4200	193	T5052.P	104/136	T5234	306	T5501	174
T4201	193	T5056	104/136/174	T5235	306	T5502	174
T4202	193	T5057	184	T5237	300	T5506	172
T4203	193	T5058	184	T5238	300	T5507	174
T4215	193	T5059	184	T5239	300	T5508	174
T4216	192	T5060	182	T5240	300	T5509	140/174
T4217	192	T5063	186	T5246	303	T5510	140/174
T4218	192	T5064	174	T5252	208	T5601	309
T4219	192	T5065	174	T5253	210	T5602	309
T4220	192	T5066	185	T5254	210	T5603	182
T5000.2	189	T5071	182	T5255	210	T5604	182
T5000.Y2	189	T5074	186	T5258	208	T5606	309
T5000.Z2	189	T5075	186	T5259	208	T5607	182
T5002	104/136	T5076	206	T5260	208	T5608	182
T5004	182	T5077	184	T5262	309	T5609.S	178
T5005	187	T5080	173	T5266	210	T5609.V	178
T5006	187	T5081	173	T5267	208	T5609.Z	178
T5011	172	T5083	173	T5268	208	T5610.S	178
T5012.T	172	T5084	173	T5269	208	T5610.V	178
T5013.1	187	T5085	173	T5270	208	T5610.Z	178
T5013.M	187	T5086	309	T5271	208	T5611.S	180
T5013.T	187	T5088	182	T5272	208	T5611.V	180
T5014.1	187	T5090	172	T5274	309	T5611.Z	180
T5014.M	187	T5091	172	T5280.T	298	T5612.S	180
T5014.T	187	T5092	171	T5281.T	298	T5612.V	180
T5015.12	187	T5094	182	T5282.T	298	T5612.Z	180
T5015.M2	187	T5095.Z	190	T5283.T	298	T5613.S	178
T5015.T2	187	T5096.Z	190	T5284.A	188/300	T5613.V	178
T5017	190	T5098	191	T5284.T	188/300	T5613.Z	178
						T5614.S	180
						T5614.V	180
						T5614.Z	180
						T5615.S	180
						T5615.V	180
						T5615.Z	180
						T6000.G	282
						T6002	282
						T6004	206
						T6005	206
						T6007.OA	206
						T6007.OB	206
						T6007.OC	206
						T6010.P	282
						T6112	206
						T6200	289
						T6201	289
						T6204	289
						T6205	289
						T6304.2	284
						T6304.C100	284
						T6309.T2	286
						T6324.T	286
						T6334	286
						T6335	284
						T6337	286
						T6337.C80	286
						T6339	286
						T6341.TG	284
						T6342	284
						T6343	284
						T6344	284
						T6344.CB150	284
						T6345	284
						T6346	286
						T6347	286
						T6402	286
						T6404	286
						T6700	284
						T7012	206
						T7051	204
						T7053.Z	204
						T7054	204
						T7056.N	204
						T7056.R	204
						T7056.T	204
						T7056.Z	204
						T7057	204

Art.	pag.	Art.	pag.	Art.	pag.				
T7066	204	T8142	36	T8187	34	T8226	70	T8322	79
T8007	28	T8143	36	T8187.Z	34	T8227	68	T8323	79
T8016	53	T8144	36	T8188	34	T8228	70	T8324	79
T8016.Z	53	T8145	48	T8188.Z	34	T8230	22	T8344	25
T8019	50	T8146	48	T8189	34	T8231	22	T8345	25
T8019.Z	50	T8147	47	T8189.Z	34	T8232	22	T8346	25
T8020	50	T8148	47	T8190	34	T8234	22	T8347	25
T8020.Z	50	T8149	48	T8190.Z	34	T8235	309	T8348	66
T8036	44	T8150	47	T8191	34	T8236	22	T8349	66
T8060	106/138	T8151	47	T8191.Z	34	T8237	22	T8350	66
T8061	106/138	T8153	66	T8192	34	T8240	78	T8401	62
T8062	106/138	T8154	51	T8192.Z	34	T8241	78	T8402	62
T8063	106/138	T8154.L	51	T8193	34	T8242	78	T8403	62
T8100	28	T8155	30	T8193.Z	34	T8243	78	T8404	62
T8101	30	T8156	30	T8194	34	T8250	76	T8415	53
T8102	42	T8157	36	T8194.Z	34	T8251	76	T8416	53
T8103	42	T8158	36	T8195	32	T8253	76	T8416.Z	53
T8104	30	T8159	38	T8195.T	32	T8254	76	T8417	53
T8105	42	T8161	40	T8195.Z	32	T8255	76	T8417.Z	53
T8106	42	T8163	35	T8196	47	T8256	73	T8418	53
T8107	44	T8163.Z	35	T8197	44	T8257	73	T8420	55
T8108	44	T8164	35	T8197.T	44	T8258	70	T8421	55
T8109	30/122	T8164.Z	35	T8197.Z	44	T8260	72	T8422	55
T8110	30	T8165	35	T8198	32	T8261	72	T8423	55
T8111	28	T8165.Z	35	T8201	68	T8262	72	T8424	55
T8112	28	T8166	35	T8202	71	T8263	72	T8425	55
T8113	28	T8166.Z	35	T8203	71	T8264	74	T8428	36
T8116.Z	77	T8167	40	T8204	68	T8265	74	T8430	54
T8117	77	T8168	42	T8205	68	T8266	74	T8431	54
T8119	42	T8169	40	T8206	68	T8267	74	T8432	54
T8120	38	T8170	48	T8207	68	T8268	74	T8433	54
T8121	38	T8171	28	T8208	71	T8269	72	T8434	54
T8122	42	T8173	44	T8209	70	T8270	71	T8435	48
T8124	38	T8175	28	T8210	70	T8271	74	T8436	48
T8126	40	T8176	30	T8211	78	T8272	74	T8437	55
T8128	42	T8177	44	T8212	78	T8273	74	T8438	48
T8129	42	T8178	47	T8213	68	T8274	77	T8439	48
T8130	38	T8179	30	T8214	68	T8275	77	T8440	56
T8131	38	T8180	40	T8215	71	T8276	77	T8440.Z	56
T8132	38	T8181	28	T8216	73	T8277	64	T8441	56
T8133	38	T8181.Z	72/122	T8218	189	T8278	64	T8441.Z	56
T8134	36	T8182	28	T8219	73	T8279	64	T8442	56
T8135	36	T8183	28	T8220	68	T8280	64	T8442.Z	56
T8136	36	T8184	30	T8221	68	T8281	64	T8443	56
T8137	36	T8185	34	T8222	71	T8282	64	T8444	56
T8138	44/104/136	T8185.Z	34	T8223	73	T8288	63	T8445	56
T8140	47	T8186	34	T8224	70	T8320	79/122	T8446	30
T8141	47	T8186.Z	34	T8225	78	T8321	79	T8447	40

Art.	pag.	Art.	pag.	Art.	pag.				
T8448	40	T8531	26	T8671	17	U0032	87	W4102	298
T8450	58	T8533	27	T8680	15	U0033	87	W4105	298
T8451	58	T8534	27	T8681	15	U0034	87	W4106	295
T8452	58	T8550	81	T8682	15	U0035	87	W4110	295
T8453	58	T8551	81	T8683	15	U0036.T	88	W4113	294
T8454	58	T8552	80	T8684	15	U0036.Y	88	W4117	294
T8455	58	T8553	80	T8685	15	U0037.T	88	W4230.2CB	296
T8456	58	T8554	80	T8686	15	U0037.Y	88	W4230.CB	296
T8457	58	T8555	80	T8687	15	W1011	294	W4231.CB	296
T8460	66	T8556	80	T8688	15	W1012	294	W4232.CB	296
T8461	66	T8557	81	T8689	15	W1013	294	W4232.I	296
T8462	66	T8558	81	T8690	15	W1014	294	W4233.CB	296
T8463	66	T8620	23	T8691	15	W1015	294	W4234.CB	296
T8464	62	T8621	23	T8700	13	W2003.F	299	W4235.CB	296
T8465	62	T8622	23	T8701	13	W2003.Q	299	W4238.CB	296
T8466	42	T8623	23	T8702	13	W2003.T	299	W4240.CB	296
T8467	40	T8630	20	T8703	13	W2003.Y	299	W4241.CB	296
T8468	40	T8631	20	T8704	13	W2006	299	W4301	298
T8469	40	T8632	20	T8705	13	W2007.F	299	W4302.Y	299
T8470	63	T8633	20	T8706	13	W2007.I	299	W4303.Y	299
T8471	63	T8634	20	T8707	13	W2007.T	299	W4330.Y	303
T8500	27	T8635	20	T8708	13	W2008.Y	299	W4330.Z	303
T8501	27	T8636	20	T8709	13	W2010	294	W4331.Z	303
T8502	27	T8640	19	T8710	13	W2012	294	W4332	303
T8503	27	T8641	19	T8711	13	W2015	294	W4401.2	299
T8504	26	T8642	19	U0011	82	W2100.B	290	W4504.Y	299
T8505	26	T8643	19	U0012	82	W2100.M	290	W4603	294
T8506	26	T8644	19	U0013	82	W2100.S	290	W4702	302
T8508	26	T8645	19	U0014	82	W2101.B	290	W4706	302
T8509	27	T8646	19	U0015	83	W2101.M	290	W4707	302
T8510	27	T8650	21	U0016	83	W2101.S	290	W4708	302
T8511	27	T8651	21	U0017	83	W3007	294	W4709.Z	302
T8513	27	T8652	21	U0018	83	W3008	294	W4711	302
T8515.G	24	T8653	21	U0019	84	W3330	292	W5002	295
T8515.I	24	T8654	21	U0020	84	W3331	292	W5101	299
T8515.T	24	T8655	21	U0021	84	W3332	292	W5102	304
T8516	24	T8656	21	U0022	84	W3333	292	W5103	304
T8521.Y	52	T8660	17	U0023	84	W3334	292	W5104	304
T8522.Y	52	T8661	17	U0024.T	88	W3335	292	W5105	304
T8523.Z	73	T8662	17	U0024.U	88	W3336	292	W5106	304
T8524.Y	52	T8663	17	U0024.Y	88	W3337	292	W5200	292
T8525.Y	52	T8664	17	U0025	89	W3338	292	W5201	299
T8526.Q	18	T8665	17	U0026	89	W3339	292	W5203	292
T8526.Y	18	T8666	17	U0027	89	W3340	292	W7001	299
T8526.Z	18	T8667	17	U0028	89	W3341	292		
T8527.Q	18	T8668	17	U0029	89	W3342	292		
T8527.Y	18	T8669	17	U0030	89	W3385	308		
T8527.Z	18	T8670	17	U0031	87	W3386	308		



SOSTIENI CON NOI

"Goccia dopo Goccia"

(drop by drop)



Qualcuno ci ha descritto come "una pioggerellina di primavera", che non fa danni, ma con le sue goccioline porta la vita, dà sollievo alla terra arsa dal sole e dà ancora speranza alle piante che avevano sete. Così vorremo fare noi: ridare speranza, gioia e voglia di vivere a tante persone in difficoltà che si trovano in zone svantaggiate del pianeta, come quelle al confine tra Myanmar e Thailandia per esempio, che ancora oggi accoglie centinaia di migliaia di persone che fuggono in condizioni disperate, e poi gli abbandonati, gli "ultimi" nascosti nei tuguri delle grandi metropoli asiatiche: quella gente è la nostra gente. Certo, "i bambini di strada" di Saigon, rappresentano per noi un impegno costante, come anche gli anziani, i disabili e coloro che non hanno più nulla e nessuno al mondo. 'Goccia dopo Goccia' vorrebbe essere sempre accanto a loro.

Queste persone sono lo scopo della nostra vita e vorremmo potervi far vedere gli occhi di quella anziana di Saigon che raccoglieva la spazzatura in strada, a cui abbiamo donato il corrispettivo di un'intera giornata di lavoro: erano occhi pieni di sorpresa, gratitudine ma soprattutto belli perché avevano ritrovato la gioia di vivere e la speranza, non li dimenticheremo mai, anzi, vorremo vederli sul volto di ogni persona a cui ci avviciniamo.

Un immenso grazie a tutti voi a nome della "nostra gente" che da oggi diventerà anche la vostra gente.

Someone described us as a "spring drizzle" that doesn't do any harm, but at the same time with its small little drops it creates life; it eases the soil burned up by the sun and it gives hope to those plants who are in need of water. This is exactly what we would like to do: give hope, joy and zest for life to those people who are struggling and find themselves in disadvantaged countries, such as the ones on the borders between Myanmar and Thailand. These countries still welcome hundreds of thousands of people who run away from very hard conditions and the abandoned ones, those who "don't matter" who live in the shacks of big Asian cities. They also welcome the "street children" of Saigon, the elders, the physically and mentally challenged and those who have nothing and no one else in the world. This is our people. "Goccia dopo Goccia" would like to stand by them because these people are our job and daily life purpose. We would like to show you the eyes of the elderly woman who was collecting trash from the streets in Saigon and to whom we donated the equivalent of a one day workpay: her eyes were full of surprise, gratitude and were most of all, magnificent because they found the hope and the joy to live again. We will never forget those eyes and we would like to see them on the face of every person we meet. A big and warm thank you to all of you from "our people" who, starting from today, will become "your people".

www.gocciadopogoccia.ch

shop on line 24/24h

Visitate il nostro sito e-commerce

leonedecorazioni.com

potrete acquistare **24 ore su 24** con un semplice "click". Troverete sempre tantissime novità e occasioni speciali nella nuova sezione OUTLET, con sconti fino al 50%!

migliaia di prodotti sempre disponibili

Leone dispone di un'ampia gamma di prodotti disponibili a magazzino permettendovi di ottimizzare i vostri acquisti in linea con le vostre esigenze. Potrete scegliere i prodotti giusti per voi tra tantissimi articoli esclusivi ed originali che vi permetteranno di esprimere al meglio lo stile che più vi piace.

garanzia soddisfatti o rimborsati

Leone vi dà la possibilità di restituire la merce acquistata entro 30 giorni dal ricevimento purchè integra e custodita all'interno dell'imballo originale.



LEONE srl

Via della Dogana 25 - 48022 Lugo (RA) Italy

Tel. +39 0545 24262

Fax +39 0545 34505

info@leonedecorazioni.com

export@leonehoreca.com (export dpt.)

leonehoreca.com

seguici su:



Leone Horeca



@leonedecorazioni



@leonehoreca

condizioni di vendita

Prezzi - I prezzi esposti sono esclusi di IVA legalmente in vigore al momento della fatturazione.

Consegna - Tramite Corriere Espresso.

Fatturazione - Ad ogni spedizione sarà allegata regolare fattura accompagnatoria. Nel vostro interesse vi preghiamo di indicarci gli esatti dati fiscali necessari a tal fine.

Pagamento - Contrassegno al ricevimento della merce ordinata.

Garanzia Leone - Gli articoli che non risultassero di pieno gradimento del cliente possono essere restituiti nella loro confezione originale ed integra, purchè entro 30 giorni dal ricevimento del pacco, e saranno integralmente rimborsati. Eventuali omaggi promozionali resteranno invece di esclusiva proprietà del cliente.

Tutela Marchio e Articoli - Tutela © Copyright. Gli articoli del presente catalogo contrassegnati dal © Copyright, sono tutelati dalle leggi n. 633 del 22.04.1941, e n. 1845 del 14.12.1942 sui diritti d'autore; di essi è quindi vietata ogni riproduzione, totale o anche parziale, non autorizzata.

Tutela Foto - Le foto presenti nel catalogo e sul sito internet

www.leonedecorazioni.com sono coperte da © Copyright.

Foro Competente - Il foro competente per ogni controversia è quello di Ravenna.

Attenzione: Vi ricordiamo che i prodotti presenti in questo catalogo sono conformi alle leggi in vigore.



Leone s.r.l.

via della Dogana, 25

48022 Lugo (RA) Italy

Tel. 0545 24262

Fax 0545 34505

info@leonedecorazioni.com

www.leonedecorazioni.com